

Autonomous Identity API

This chapter is targeted to developers who want to access Autonomous Identity using the REST Application Programming Interface (API).

ForgeRock® Autonomous Identity is an entitlements and roles analytics system that lets you fully manage your company's access to your data.

An entitlement refers to the rights or privileges assigned to a user or thing for access to specific resources. A company can have millions of entitlements without a clear picture of what they are, what they do, and who they are assigned to. Autonomous Identity solves this problem by using advanced artificial intelligence (AI) and automation technology to determine the full entitlements landscape for your company. The system also detects potential risks arising from incorrect or over-provisioned entitlements that lead to policy violations. Autonomous Identity eliminates the manual re-certification of entitlements and provides a centralized, transparent, and contextual view of all access points within your company.



About the API

Learn about the Autonomous Identity API.



Obtain the API key

Learn how to get an API key.



API service

Access the API Service endpoints.



Authentication

Access the Authentication endpoints.

SSO

Access the SSO endpoints.



Config

Access the Config endpoints.



Report

Access the Report API.



Company view

Access the Company View API.



User details

Access the user details endpoints.



Access control

Access the Access Control endpoints.



Applications

Access the applications endpoints.



Entitlements

Access the entitlements endpoints.



Assignments

Access the assignments endpoint.



Rules

Access the rules endpoints.



Filters

Access the filters endpoints.



Roles

Access the roles endpoints.



Ingest

Access the ingest endpoints.



Jobs

[Access the jobs endpoints.](#)

About the Autonomous Identity API

Autonomous Identity provides a RESTful application programming interface (API) that lets you use HTTP request methods (GET, PUT, and POST) to interact with the system and its components. The API lets a developer make requests to send or receive data to an Autonomous Identity endpoint, a point where the API communicates with the system. The data that is sent or returned is in JavaScript Object Notation (JSON) format.

IMPORTANT

With the release of version 2021.8.4, Autonomous Identity no longer provides a Swagger client that you can access on the console. The Swagger UI was removed to tighten security within Autonomous Identity. However, you can download the Autonomous Identity API and import it into Postman.

WARNING

You cannot import the Autonomous Identity API into Swagger as there is an existing CORS issue that breaks functionality.

Using Postman

Download the Autonomous Identity API

1. On an upgraded Autonomous Identity instance, open a browser, and log in using your account at <https://autoid-ui.forgerock.com/>.
2. Point your browser to <https://autoid-ui.forgerock.com/api/swagger>. An Opening Swagger dialog appears.
3. Save the file as `api.yml` or `conf.yml` to your local server or laptop.
4. Open Postman, and click **Import**. The file is imported into Postman.
5. Click **Zoran-API-Service**.

▼ [Click an example](#)

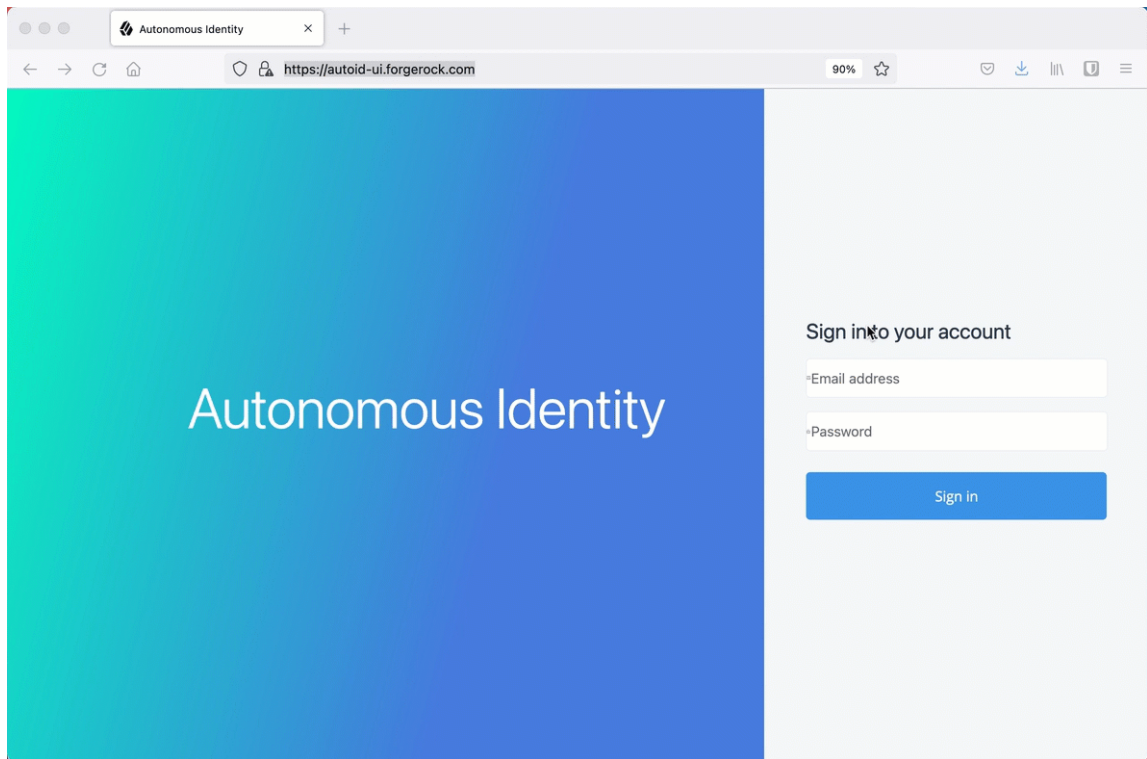

You now can access the Autonomous Identity API in Postman.

Generate an API key

Autonomous Identity gives an administrator the ability to generate API keys for those who want to access certain endpoints using REST. Administrators can create an API from the Self-Service page of the Autonomous Identity UI.

NOTE

As of this release, only the Ingest endpoints use the API key.

IMPORTANT

To use an API token, you need both the tenant ID that the API key belongs to, and the API token itself.

Obtain the tenant ID

In Autonomous Identity 2021.8.0 and later, the tenant ID is set as an environment variable that you can easily access.

- On the target node, get the tenant ID.

```
$ env | grep TENANT_ID
TENANT_ID=8700f5cb-eaca-461e-8c2e-245a25f2399d
```

Create an API key using the UI

Administrators can create API keys on the Self-Service page of the Autonomous Identity UI.

1. On the Autonomous Identity UI, click the admin drop-down on the top-left of the page.
2. Click **Self Service**.
3. Click the **API Keys** tab.
4. Click **Generate API Key**.
5. Set the name, description, and expiration date for API key, and then click **Create**.
6. Make sure to make a copy of the key in the box as it cannot be retrieved once the dialog box is closed. The new API key appears in the list of keys on the API Keys page.

▼ [Click an example](#)

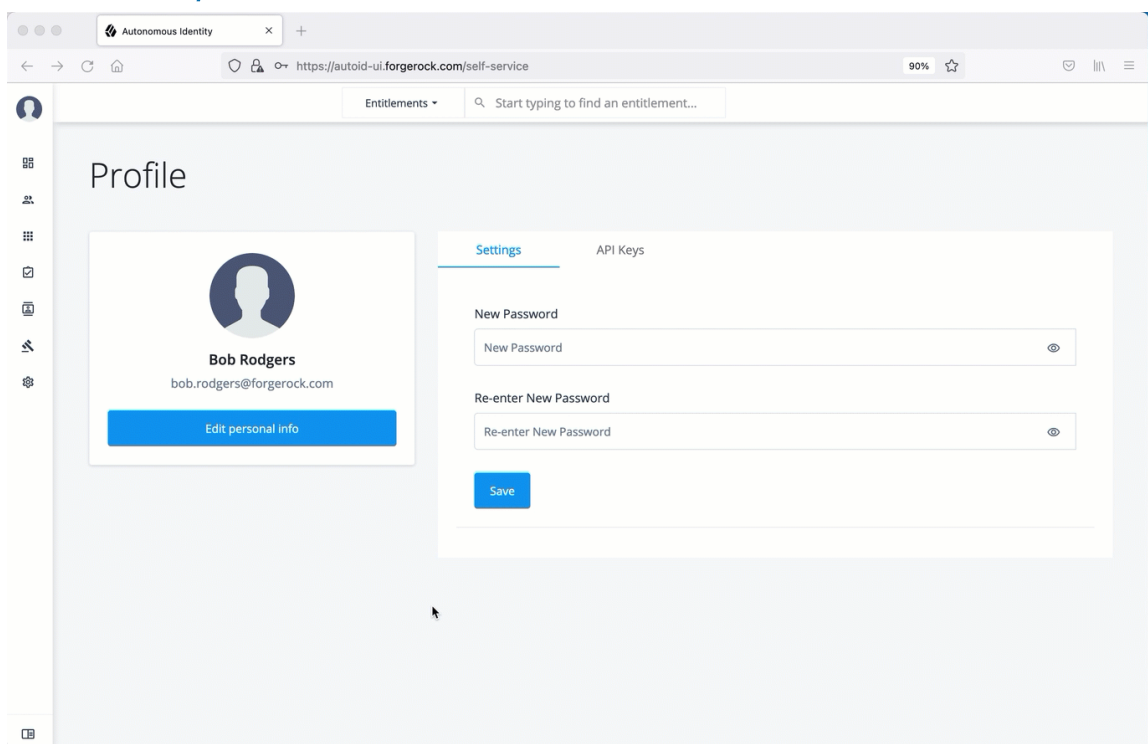

Deactivate API keys using the UI

Administrators can revoke or delete API keys. Use the following procedure to revoke an API key.

1. On the Autonomous Identity UI, click the admin drop-down on the top-left of the page.
2. Click **Self Service**.
3. Click the **API Keys** tab.

4. In the Search field, enter the API key.
5. In the list of API keys, click the three dots, and select **Revoke**. This action deletes the API key for use.

▼ [Click an example](#)

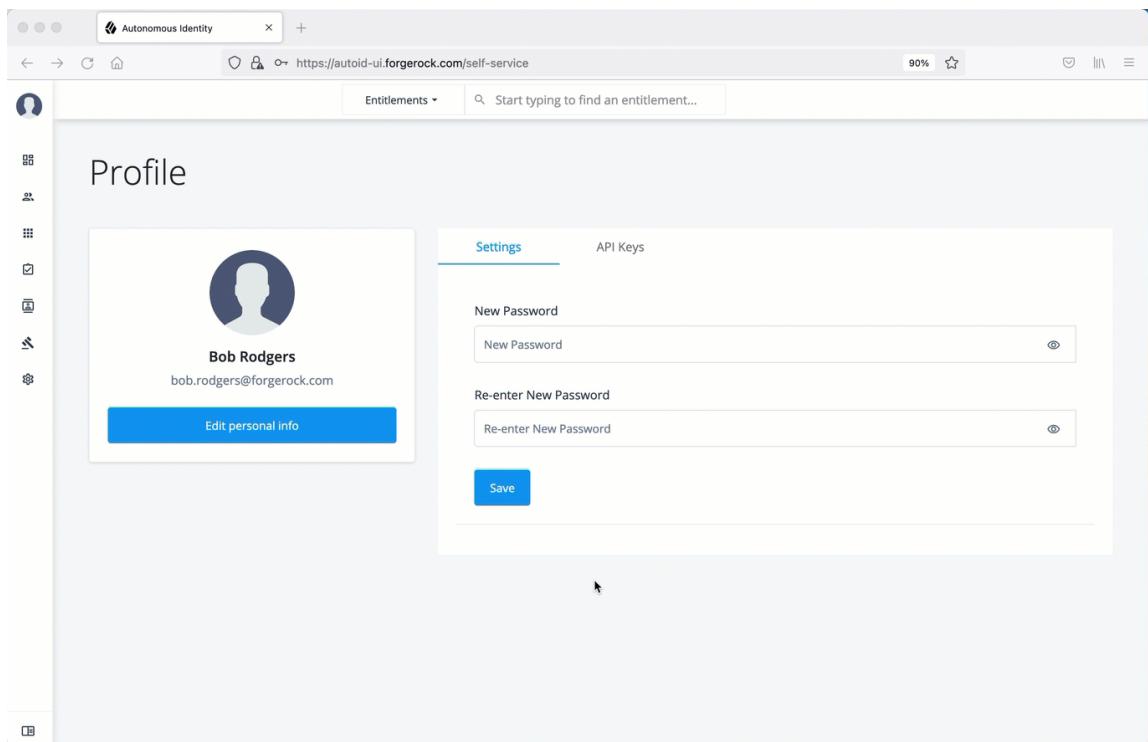

Create an API key using curl

Administrators can create API keys on the command line using curl commands.

1. Open a terminal, and create an authentication bearer token for an admin user:

```
curl -k -X POST \
https://autoid-ui.forgerock.com/api/authentication/login \
-H 'Content-Type: application/json' \
-d '{
  "username": "bob.rodgers@forgerock.com",
  "password": "Welcome123"
}'
```

The response is:

```
{
  "user": {
    "dn":
    "cn=bob.rodgers@forgerock.com,ou=People,dc=zoran,dc=com",
    "controls": [],
    "displayName": "Bob Rodgers",
```

```
    "gidNumber": "999",
    "uid": "bob.rodgers",
    "_groups": [
      "Zoran User",
      "Zoran Admin"
    ]
  },
  "token": "token_value"
}
```

2. Set the TOKEN environment variable:

```
export TOKEN=token_value
```

3. Generate a new API key:

```
curl -k -X POST \
https://autoid-ui.forgerock.com/api/admin/createApiToken \
-H "Authorization: Bearer $TOKEN" \
-H 'Content-Type: application/json' \
-d '{
  "name": "Ingest Key",
  "description": "API key for ingestion endpoints",
  "expiration": "2022-01-02"
}'
```

The response is:

```
{
  "token": "19412ace-1d99-44b2-88e0-16136fc5c77a"
}
```

API key examples

The following curl example illustrates how to use the API key to get a datasource ID for an ingestion job:

1. Obtain an API key from an administrator. See [Create API Keys](#).
2. Obtain the tenant ID using the environment variable.

```
$ env | grep TENANT_ID
TENANT_ID=8700f5cb-eaca-461e-8c2e-245a25f2399d
```

3. Query Autonomous Identity's Java API Service (JAS) to obtain a data source ID using the API Key (for example, '1b7789f0-6c2f-4afa-a84b-a65a28f5c1a1'):

```
curl 'https://autoid-ui.forgerock.com/jas/datasource/search' \
  -H 'authority: autoid-ui.forgerock.com' \
  -H 'sec-ch-ua: "Chromium";v="92", " Not A;Brand";v="99",
"Google Chrome";v="92"' \
  -H 'accept: application/json, text/plain, /' \
  -H 'x-tenant-id: 8700f5cb-eaca-461e-8c2e-245a25f2399d' \
  -H 'authorization: 1b7789f0-6c2f-4afa-a84b-a65a28f5c1a1' \
  -H 'sec-ch-ua-mobile: ?0' \
  -H 'user-agent: Mozilla/5.0 (Macintosh; Intel Mac OS X
10_15_7) AppleWebKit/537.36 (KHTML, like Gecko)
Chrome/92.0.4515.159 Safari/537.36' \
  -H 'content-type: application/json' \
  -H 'origin: https://autoid-ui.forgerock.com' \
  -H 'sec-fetch-site: same-origin' \
  -H 'sec-fetch-mode: cors' \
  -H 'sec-fetch-dest: empty' \
  -H 'referrer: https://autoid-ui.forgerock.com/data-sources' \
  \
  -H 'accept-language: en-US,en;q=0.9' \
  --data-raw '{
    "query": {
      "sort": [
        {
          "datasource_id.keyword": {
            "order": "desc"
          }
        }
      ],
      "size": 10,
      "track_total_hits": true,
      "query": {
        "match_all": {}
      }
    }
  }' \
  --compressed \
  --insecure
```

The response includes the datasource ID:

```

{
  "took": 8,
  "timed_out": false,
  "_shards": {
    "total": 3,
    "successful": 3,
    "skipped": 0,
    "failed": 0
  },
  "hits": {
    "total": {
      "value": 1,
      "relation": "eq"
    },
    "max_score": null,
    "hits": [
      {
        "_index": "autonomous-iam_common_datasources_latest",
        "_type": "_doc",
        "_id":
"259b80c7693e92c4c29bd64deac4cd99826d427027645c9413afdb3f083b8
91d8d34cefaebd5fcf098c066dc1a4da2879d8732d59bfd2e239a285184f8e
7a35b",
        "_score": null,
        "_source": {
          "datasource_id": "2d7a6a76-469c-4035-b312-
fb1daf104e98",
          "name": "Showcase-CSV-DS",
          "sync_type": "full",
          "icon": "apps",
          "isActive": true,
          "entityTypes": {
            "/autoid/system/datasources/2d7a6a76-469c-4035-
b312-fb1daf104e98/applications": {
              "uri": {
                "file": "file:/data/input/applications.csv"
              }
            },
            "/autoid/system/datasources/2d7a6a76-469c-4035-
b312-fb1daf104e98/assignments": {
              "uri": {
                "file": "file:/data/input/assignments.csv"
              }
            }
          },
          "/autoid/system/datasources/2d7a6a76-469c-4035-

```

```
b312-fb1daf104e98/entitlements": {
    "uri": {
        "file": "file:/data/input/entitlements.csv"
    }
},
"/autoid/system/datasources/2d7a6a76-469c-4035-
b312-fb1daf104e98/identities": {
    "uri": {
        "file": "file:/data/input/identities.csv"
    }
},
"connectionSettings": {
    "csv": {}
},
"metadata": {
    "contextId": "scripts",
    "entityType": "/common/datasources",
    "primaryKey": "2d7a6a76-469c-4035-b312-
fb1daf104e98",
    "entityPath": "/common/datasources/2d7a6a76-469c-
4035-b312-fb1daf104e98",
    "entityDefinition": "datasources",
    "namespace": "/common",
    "branch": "actual",
    "created": "2021-08-25T03:53:33.634Z",
    "tenantId": "autonomous-iam"
}
},
"sort": [
    "2d7a6a76-469c-4035-b312-fb1daf104e98"
]
}
}
}
}
```

4. Make sure your client that accesses the JAS configuration has something similar to the following:

```
public static final String CONFIG_JAS_API_TOKEN =
    "JAS_API_KEY";
public static final String CONFIG_JAS_TENANT_ID = "TENANT_ID";
```

API service

The following are Autonomous Identity API Service endpoints:

GET /health-check

GET /health-check

Check that the Autonomous Identity API service is running. Get uptime statistics. [All]

Endpoint

```
/health-check
```

Headers

```
Content-Type    application/json
```

Body

Example Request

```
curl --request GET "<instance-IP>/health-check" \  
--header "Content-Type: application/json"
```

Example Response

```
{  
  "status": "zoran-api: OK",  
  "uptime": 5412.465875997,  
  "uptimeFormatted": "1:30:12"  
}
```

GET /version

GET /version

Get the version number of this service. [All]

Endpoint

```
/version
```

Headers

```
Content-Type    application/json
```

Body

Example Request

```
curl --request GET "https://autoid-  
api.forgerock.com/version" \  
--header "Content-Type: application/json"
```

Example Response

```
{  
  "version": "1.0",  
}
```

Authentication

The following are Autonomous Identity authentication endpoints:

POST /api/authentication/login

POST /api/authentication/login

Log in to the system. The endpoint accepts the `username` and `password` in the body of the request. The token provided has an expiry date that can be obtained by decoding the returned JWT and using the `exp` data inside the token. [All]

Endpoint

```
/api/authentication/login
```

Headers

```
Content-Type      application/json
```

Body

```
{  
    "username": "admin@test.com",  
    "password": "test"  
}
```

Example Request

```
curl --location --request POST 'https://autoid-  
api.forgerock.com/api/authentication/login' \  
--header 'Content-Type: application/json' \  
--data-raw '{  
    "username": "admin@test.com",  
    "password": "test"  
}'
```

Example Response

```
{  
  "user": {  
    "dn": "cn=test.user@test.com,dc=example,dc=org",  
    "controls": [],  
    "gidNumber": "7777",  
    "uid": "test.user",  
    "displayName": "Test User",  
    "_groups": [  
      "Admin"  
    ]  
  }
```

```
  },  
  "token": "123456"  
}
```

GET /api/authentication/verify

GET /api/authentication/verify

Verify the authenticity of a bearer token.

Endpoint

```
/api/authentication/verify
```

Authorization

Token	<token>
--------------	----------------------

Headers

Content-Type	application/json
---------------------	-------------------------

Body

```
..
```

Example Request

```
curl --location --request GET 'https://autoid-  
api.forgerock.com/api/authentication/verify' \  
--header 'Content-Type: application/json'
```

Example Response

```
{
  "user": {
    "controls": [],
    "displayName": "Bob Rodgers",
    "email": "bob.rodgers@forgerock.com",
    "dn":
"cn=bob.rodgers@forgerock.com,ou=People,dc=zoran,dc=com",
    "gidNumber": "999",
    "uid": "bob.rodgers",
    "_groups": [
      "Zoran Admin"
    ],
    "iat": 1628893019,
    "exp": 1628936219,
    "aud": "http://my.service",
    "sub": "6711197"
  }
}
```

POST /api/authentication/renewToken

POST /api/authentication/renewToken

Renew a token for the system. The endpoint accepts the JWT in the header
Authorization: Bearer JWT . The expiry time of the token is reset and return in the new token. [All]

Endpoint

```
/api/authentication/renewToken
```

Authorization

```
Token           <token>
```

Headers

```
Content-Type    application/json
```

Body

```
''
```

Example Request

```
curl --location --request POST 'https://autoid-  
api.forgerock.com/api/authentication/renewToken' \  
--header 'Content-Type: application/json' \  
--data-raw ''
```

Example Response

```
{  
  "user": {  
    "dn": "cn=test.user@test.com,dc=example,dc=org",  
    "controls": [],  
    "gidNumber": "7777",  
    "uid": "test.user",  
    "displayName": "Test User",  
    "_groups": [  
      "Admin"  
    ]  
  },  
  "token": "123456"  
}
```

GET /api/authentication/actions

GET /api/authentication/actions

Retrieve the permitted actions of the currently authenticated user. [All]

Endpoint

```
/api/authentication/action
```

Headers

Content-Type **application/json**

Example Request

```
curl --location --request GET 'https://autoid-  
api.forgerock.com/api/authentication/actions' \  
--header 'Content-Type: application/json'
```

Example Response

```
{  
  "userActions": [  
    "*" ] ,  
  "roleTitle": "Unknown",  
  "homepage": "company"  
}
```

SSO

The following are Autonomous Identity SSO endpoints:

GET /api/sso/start

GET /api/sso/start

Endpoint to initiate SSO. [All]

Endpoint

/api/sso/start

Authorization

Token **<token>**

Headers

Content-Type /

Example Request

```
curl --request GET "https://autoid-  
api.forgerock.com/api/sso/start" \  
--header "Content-Type: /"
```

GET /api/sso/finish

GET /api/sso/finish

Endpoint to finish SSO. [All]

Endpoint

/api/sso/finish

Authorization

Token <token>

Headers

Content-Type /

Example Request

```
curl --request GET "https://autoid-  
api.forgerock.com/api/sso/finish" \  
--header "Content-Type: /"
```

GET /api/slo/logout

GET /api/slo/logout

Endpoint to log out of SSO.

Endpoint

```
/api/slo/logout
```

Authorization

```
Token            <token>
```

Headers

```
Content-Type     application/json
```

Example Request

```
curl --request GET "https://autoid-  
api.forgerock.com/api/slo/logout" \  
--header "Content-Type: application/json"
```

Config

The following are Autonomous Identity config endpoint:

GET /api/config

GET /api/config

Get the configuration. This endpoint is mainly used by the Autonomous Identity UI microservice to get values stored in Consul. [All]

Endpoint

/api/config

Headers

Content-Type **application/json**

Example Request

```
curl --request GET "https://autoid-  
api.forgerock.com/api/config" \  
--header "Content-Type: application/json"
```

Example Response

```
{  
  "thresholds": {  
    "top": 1.01,  
    "high": 0.75,  
    "medium": 0.35,  
    "low": 0,  
    "autoAccess": 0.5  
  },  
  "volumeThresholds": {  
    "high": 90,  
    "low": 20  
  },  
  "mostAssignedStats": {  
    "count": 100  
  },  
  "highVolumeStats": {  
    "high": {  
      "minScore": 0.9,  
      "minUsersCount": 100  
    },  
    "low": {  
      "maxScore": 0.2,  
      "minUsersCount": 100  
    }  
  },  
}
```

```
"authorizers": {
  "ldap": true,
  "oidc": false
}
```

GET /api/admin/reloadUIConfig

GET /api/admin/reloadUIConfig

Reload justification and filterable attributes configuration from JAS. [User, Supervisor, Ent Owner, App Owner, Admin]

Endpoint

```
/api/admin/reloadUIConfig
```

Headers

```
Content-Type /
```

Example Request

```
curl --request GET "https://autoid-  
api.forgerock.com/api/admin/reloadUIConfig" \  
-H "accept: /"
```

POST /api/admin/updateUser

POST /api/admin/updateUser

Update credentials for a user.

Endpoint

```
/api/admin/updateUser
```

Authorization

```
<Bearer Token JWT-value>
```

Body

```
{  
    email: "john.doe@forgerock.com",  
    password: "password",  
    groups: ["Zoran Supervisor", "Zoran Role Engineer"]  
}
```

Example Request

```
curl --location --request POST 'https://autoid-  
api.forgerock.com/api/admin/updateUser' \  
--header 'Content-Type: application/json' \  
--header 'Authorization: Bearer <token>' \  
--data-raw '{  
    "email": "john.doe@forgerock.com",  
    "password": "password",  
    "groups": ["Zoran Supervisor", "Zoran Role  
Engineer"]  
}'
```

Example Response

```
{ message: 'success' }
```

POST /api/admin/updateSelf

POST /api/admin/updateSelf

Update credentials for a user.

Endpoint

/api/admin/updateSelf

Authorization

<Bearer Token JWT-value>

Body

```
{
    email: "john.doe@forgerock.com",
    password: "password",
    groups: ["Zoran Supervisor", "Zoran Role Engineer"]
}
```

Example Request

```
curl --location --request POST 'https://autoid-
api.forgerock.com/api/admin/updateSelf' \
--header 'Content-Type: application/json' \
--header 'Authorization: Bearer <token>' \
--data-raw '{
    "email": "john.doe@forgerock.com",
    "password": "password",
    "groups": ["Zoran Supervisor", "Zoran Role
Engineer"]
}'
```

Example Response

```
{ message: 'success' }
```

POST /api/admin/disableUser

POST /api/admin/disableUser

Disable user account.

Endpoint

```
/api/admin/disableuser
```

Authorization

```
<Bearer Token JWT-value>
```

Body

```
{  
    email: "john.doe@forgerock.com"  
}
```

Example Request

```
curl --location --request POST 'https://autoid-  
api.forgerock.com/api/admin/disableUser' \  
--header 'Content-type: application/json' \  
--header 'Authorization: Bearer <token>' \  
--data-raw '{  
    "email": "john.doe@forgerock.com"  
}'
```

Example Response

```
{ message: 'success' }
```

POST /api/admin/enableUser

POST /api/admin/enableUser

Enable a user account.

Endpoint

```
/api/admin/enableUser
```

Authorization

```
<Bearer Token JWT-value>
```

Body

```
{  
    email: "john.doe@forgerock.com"  
}
```

Example Request

```
curl --location --request POST "https://autoid-  
api.forgerock.com/api/admin/enableUser" \  
--header "Content-Type: application/json" \  
--header "Authorization: Bearer <token>" \  
--data-raw '{  
    "email": "john.doe@forgerock.com"  
}'
```

Example Response

```
{ message: 'success' }
```

POST /api/admin/createUser

POST /api/admin/createUser

Create credentials for a user

Endpoint

```
/api/admin/createUser
```

Authorization

```
<Bearer Token JWT-value>
```

Body

```
{
  dn:
  "cn=john.doe@forgerock.com,ou=People,dc=zoran,dc=com",gidNu
  mber: "321",
  email: "john.doe@forgerock.com",
  password: "password",
  controls: [],
  displayName: "John Doe",
  uid: "john.doe",
  groups: ["Zoran Admin"]
}
```

Example Request

```
curl --request POST "https://autoid-
api.forgerock.com/api/admin/createUser" \
--header "Content-Type: application/json" \
--header "Authorization: Bearer <token>" \
--data-raw '{
  dn:
  "cn=john.doe@forgerock.com,ou=People,dc=zoran,dc=com",gidNu
  mber: "321",
  email: "john.doe@forgerock.com",
  password: "password",
  controls: [],
  displayName: "John Doe",
  uid: "john.doe",
  groups: ["Zoran Admin"]
}'
```

Example Response

```
{ message: 'success' }
```

POST /api/admin/createApiToken

POST /api/admin/createApiToken

Create API credentials (token) for a user.

Endpoint

```
/api/admin/createApiToken
```

Authorization

```
<Bearer Token JWT-value>
```

Body

```
{  
  name: "John Doe",  
  description: "description",  
  expiration: "2021-08-12T12:00:00.000Z"  
}
```

Example Request

```
curl --request POST "https://autoid-  
api.forgerock.com/api/admin/createApiToken" \  
--header "Content-Type: application/json" \  
--header "Authorization: Bearer <token>" \  
--data-raw '{  
  name: "John Doe",  
  description: "description",  
  expiration: "2021-08-12T12:00:00.000Z"  
}'
```

Example Response

```
{ token: uuid }
```

POST /api/admin/revokeApiToken

POST /api/admin/revokeApiToken

Revoke API credentials for a user.

Endpoint

```
/api/admin/revokeApiToken
```

Authorization

```
<Bearer Token JWT-value>
```

Body

```
{  
    token: "11b57769-d436-4357-bc1c-0e0b9c6a49b6"  
}
```

Example Request

```
curl --location --request POST "https://autoid-  
api.forgerock.com/api/admin/revokeApiToken" \  
--header "Content-Type: application/json" \  
--header "Authorization: Bearer <token>" \  
--data-raw '{  
    token: "11b57769-d436-4357-bc1c-0e0b9c6a49b6"  
}'
```

Example Response

```
{ message: 'User token disabled' }
```

GET /api/admin/verifyApiToken/{token}

GET /api/admin/verifyApiToken/{token}

Verify that an API token is valid

Endpoint

```
/api/admin/verifyApiToke
```

Authorization

```
<Bearer Token JWT-value>
```

Example Request

```
curl --request GET "https://autoid-  
api.forgerock.com/api/admin/verifyApiToken/da0b5228-1e11-  
4278-ad1c-f0938fccdf82" \  
--header "Content-Type: application/json" \  
--header "Authorization: Bearer <token>"
```

Example Response

```
{  
  "name": "John Doe",  
  "description": "description",  
  "expiration": "2021-08-17T12:00:00.000Z",  
  "is_valid": true,  
  "creator": "bob.rodgers@forgerock.com",  
  "modifier": "bob.rodgers@forgerock.com"  
}
```

GET /api/admin/getTokens

GET /api/admin/getTokens

Get a list of tokens.

Endpoint

```
/api/admin/getTokens
```

Authorization

```
<Bearer Token JWT-value>
```

Body

```
{
    "maxResults": 6,
    "offset": 5
}
```

Example Request

```
curl --request GET "https://autoid-
api.forgerock.com/api/admin/getTokens" \
--header "Content-Type: application/json" \
--header "Authorization: Bearer <token>" \
--data-raw '{
    "maxResults": 6,
    "offset": 5
}'
```

Example Response

```
[{
  "token": "da0b5228-1e11-4278-ad1c-f0938fccdf82",
  "name": "John Doe",
  "description": "description",
  "expiration": "2021-08-17T12:00:00.000Z",
  "is_valid": true,
```

```
"creator": "bob.rodgers@forgerock.com",  
"modifier": "bob.rodgers@forgerock.com"  
}]
```

GET /api/admin/getUsers

GET /api/admin/getUsers

Get a list of users.

Endpoint

```
/api/admin/getUsers
```

Authorization

```
<Bearer Token JWT-value>
```

Body

```
{  
    maxResults: 6,  
    offset: 5,  
    sortBy: uid | displayName | gidNumber  
}
```

Example Request

```
curl --location --request GET "https://autoid-  
api.forgerock.com/api/admin/getUsers" \  
--header "Content-Type: application/json" \  
--header "Authorization: Bearer <token>" \  
--data-raw '{  
    maxResults: 6,  
    offset: 5,  
    sortBy: uid  
'
```

Example Response

```
[{
  "controls": [],
  "displayName": "David Elliott",
  "email": "david.elliott@forgerock.com",
  "dn":
  "cn=david.elliott@forgerock.com,ou=People,dc=zoran,dc=com",
  "gidNumber": "809",
  "uid": "david.elliott",
  "_groups": [
    "Zoran Entitlement Owner"
  ],
  "enabled": true
}]
```

Report

Autonomous Identity captures information in its log files that are useful when troubleshooting problems. You can access the reports using REST calls to the Report API endpoint.

POST /api/report

POST /api/report

Get reporting data. [All]

Endpoint

```
/api/report
```

Authorization

```
<Bearer Token JWT-value>
```

Headers

Content-Type **application/json**

Params

fields

Body

```
{
  "fields": [
    "id",
    "type",
    "batch_id",
    "original",
    "update"
  ],
  "reportType": "EventBasedCertification"
}
```

Example Request

```
curl --request POST "https://autoid-
api.forgerock.com/api/report" \
--header "Content-Type: application/json" \
--header 'Authorization: Bearer <token>' \
--data-raw '{
  "fields": [
    "id",
    "type",
    "batch_id",
    "original",
    "update"
  ],
  "reportType": "EventBasedCertification"
}'
```

Company View

The following are Autonomous Identity company view endpoints:

GET /api/companyview

GET /api/companyview

Get the data for company overview dashboard data. [Executive, Admin]

Endpoint

```
/api/companyview
```

Authorization

```
<Bearer Token JWT-value>
```

Example Request

```
curl --request GET "https://autoid-  
api.forgerock.com/api/companyview" \  
--header "Content-Type: application/json"
```

Example Response

```
{  
  "companyView": {  
    "employeeTypes": [  
      {  
        "type": "Employee",  
        "high": 723,  
        "low": 27,  
        "medium": 1796,  
        "null_conf": 0,  
        "total": 2546  
      },  
      {
```

```

        "type": "Non-Employee",
        "high": 867,
        "low": 14,
        "medium": 1768,
        "null_conf": 0,
        "total": 2649
    }
],
"employees_wo_manager": 0,
"employees_w_manager": 5200,
"entitlements_without_roleowners": 0,
"entitlements_with_roleowners": 2456,
"total_employees": 5200,
"coverage": {
    "total": 2456,
    "covered": 2456,
    "not_covered": 0
},
"entitlementsDistribution": {
    "no_users": 0,
    "one_user": 0,
    "zero_to_five_users": 1,
    "five_to_ten_users": 1064,
    "ten_to_hundred_users": 1549,
    "hundred_to_onek_user": 35,
    "onek_to_tenk_users": 0,
    "tenk_users": 0,
    "hundredk_users": 0
}
}
}

```

GET /api/companyview/allEntitlementsAvgGroups

GET /api/companyview/allEntitlementsAvgGroups

Get the average confidence score list for the company view chart. [Executive, Admin]

Endpoint

```
/api/companyview/allEntitlementAvgGroups
```

Authorization

```
<Bearer Token JWT-value>
```

Example Request

```
curl --request GET "https://autoid-  
api.forgerock.com/api/companyview/allEntitlementAvgGroups"  
\  
--header "Content-Type: application/json"
```

Example Response

```
{  
  "entitlementList": [  
    {  
      "start": 0,  
      "end": 0.05,  
      "entitlementCount": 2  
    },  
    {  
      "start": 0.06,  
      "end": 0.1,  
      "entitlementCount": 14  
    }  
  ]  
}
```

GET /api/companyview/mostCriticalEntitlements

GET /api/companyview/mostCriticalEntitlements

Get the most critical entitlements list. [Executive, Admin]

Endpoint

```
/api/companyview/mostCriticalEntitlements
```

Authorization

```
<Bearer Token JWT-value>
```

Example Request

```
curl --request GET "https://autoid-  
api.forgerock.com/api/companyview/mostCriticalEntitlements"  
\  
--header "Content-Type: application/json"
```

Example Response

```
[  
  {  
    "org": "organization",  
    "entt_id": "ent1",  
    "avg_conf_score": 0.04,  
    "entt_name": "Ent 1",  
    "high": 0,  
    "low": 1,  
    "medium": 0,  
    "seq": 0,  
    "total_employees": 6  
  },  
  {  
    "org": "organization",  
    "entt_id": "ent2",  
    "avg_conf_score": 0.04571,  
    "entt_name": "Ent 2",  
    "high": 0,  
    "low": 1,  
    "medium": 0,  
    "seq": 1,  
    "total_employees": 7  
  }  
]
```

GET /api/companyview/assignmentStats

GET /api/companyview/assignmentStats

Get the total assignments, low/high confidence, high volume and low/high confidence, most assigned [Executive, Admin]

Endpoint

```
/api/companyview/assignmentsStats
```

Authorization

```
<Bearer Token JWT-value>
```

Params

```
assignmentLimit 1  
highVolumeHighMinScore 0.9  
highVolumenHighMinUsersCount 100  
highVolumenLowMaxScore 0.2  
highVolumeLowMinUsersCount 100
```

Example Request

```
curl --request GET "https://autoid-  
api.forgerock.com/api/companyview/assignmentsStats?  
assignmentsLimit=5" \  
--header "Content-Type: application/json"
```

Example Response

```
{  
  "total": 47670,  
  "high": 13145,  
  "low": 4992,  
  "unscored": 4986,  
  "mostAssigned": [  
    {  
      "count": 344,
```

```
        "entitlement": "ent1"
      }
    ],
    "mostAssignedCount": 35,
    "highVolume": {
      "high": 23,
      "low": 17
    }
  }
}
```

GET

`/api/companyview/assignmentHistConfSummary/{year}/{month}`

GET /api/companyview/assignmentHistConfSummary/{year}/{month}

Get the number of high, medium, and low confidence assignments for the past 12-month period ending in a given year and month. [Executive, admin]

Endpoint

```
/api/companyview/assignmentsHistConfSummary/2020/01
```

Authorization

```
<Bearer Token JWT-value>
```

Example Request

```
curl --request GET "https://autoid-  
api.forgerock.com/api/companyview/assignmentsHistConfSummar  
y/2020/1" \  
--header "Content-Type: application/json"
```

Example Response

```
[  
  {  
    "year": 0,
```

```
    "month": 0,  
    "highConf": 0,  
    "medConf": 0,  
    "lowConf": 0,  
    "total": 0  
  }  
]
```

User Details

The following are Autonomous Identity user details endpoints:

POST /api/userDetails

POST /api/userDetails

Obtain the employee details for Identities views. [User, Supervisor, Ent Owner, App Owner, Admin] NOTE: This is a POST due to the endpoint receiving a JSON body query.

Endpoint

```
/api/userDetails
```

Authorization

```
<Bearer Token JWT-value>
```

Headers

```
Content-Type      application/json
```

Body

```
{  
  "employeeId": "john.doe",  
  "sortDir": "asc, desc",
```

```
"lastEntitlementId": "Web_NAS_Share_Case Management_7HQ",
"lastRecommendedEnttId": "string"
}
```

Example Request

```
curl --request POST "https://autoid-
api.forgerock.com/api/userDetails" \
--header "Content-Type: application/json" \
--header "Authorization: Bearer <token>" \
--data-raw '{
  "employeeId": "john.doe",
  "sortDir": "asc, desc",
  "lastEntitlementId": "Web_NAS_Share_Case
Management_7HQ",
  "lastRecommendedEnttId": "string"
}'
```

Example Response

```
{
  "recommendedEntt": {
    "predictions": [
      {
        "usr_key": "john.doe",
        "ent": "ent1",
        "conf": "0.88",
        "freq": "10.0",
        "frequion": "9",
        "rule": [
          {
            "title": "Chief",
            "value": "Yes"
          },
          {
            "title": "Employee Type",
            "value": "Employee"
          }
        ]
      },
      {
        "entt": {
          "entitlement": "Ent 1",
```

```

        "app_id": "app1",
        "role": "role.owner",
        "app_name": "App 1",
        "entitlement_name": "Ent 1",
        "high_risk": "High",
        "roleOwnerDisplayName": "Role Owner",
        "requestorCanAccess": false
    }
},
{
    "usr_key": "john.doe",
    "ent": "ent2",
    "conf": "1.00",
    "freq": "4.0",
    "frequion": "4",
    "rule": [
        {
            "title": "Job Code Name",
            "value": "Business Representative"
        },
        {
            "title": "Line of Business",
            "value": "Portfolio Management"
        },
        {
            "title": "Department",
            "value": " South"
        },
        {
            "title": "Employee Type",
            "value": "Employee"
        }
    ],
    "entt": {
        "entitlement": "ent2",
        "app_id": "app1",
        "role": "role.owner",
        "app_name": "App 1",
        "entitlement_name": "Ent 2",
        "high_risk": "High",
        "roleOwnerDisplayName": "Role Owner",
        "requestorCanAccess": true
    }
}
],

```

```

    "entitlementsCount": 14,
    "entitlementsRemainingCount": 9,
    "lastEntitlementId": "ent2"
  },
  "userEntt": [
    {
      "user": "john.doe",
      "entitlement": "ent3",
      "app_id": "app1",
      "app_name": "App 1",
      "entitlement_name": "Ent 3",
      "freq": "10.0",
      "frequnion": "9",
      "high_risk": "High",
      "justification": [
        {
          "title": "Chief",
          "value": "Yes"
        },
        {
          "title": "Employee Type",
          "value": "Employee"
        }
      ],
      "score": 0.88,
      "user_name": "John Doe",
      "lastAccessed": "2020-01-01 00:00:00",
      "requestorCanAccess": false,
      "rawJustification": [
        "CHIEF_YES_NO_Yes",
        "USR_EMP_TYPE_Employee"
      ]
    },
    {
      "user": "john.doe",
      "entitlement": "ent4",
      "app_id": "app1",
      "app_name": "App 1",
      "entitlement_name": "Ent 4",
      "freq": "4.0",
      "frequnion": "4",
      "high_risk": "High",
      "justification": [
        {
          "title": "Job Code Name",

```



```

        "value": "Business Representative"
    },
    {
        "title": "Line of Business",
        "value": "Portfolio Management"
    },
    {
        "title": "Department",
        "value": " South"
    },
    {
        "title": "Employee Type",
        "value": "Employee"
    }
],
"score": 1,
"user_name": "John Doe",
"lastAccessed": "2020-01-01 00:00:00",
"requestorCanAccess": false,
"rawJustification": [
    "JOBCODE_NAME_Business Representative",
    "LINE_OF_BUSINESS_Portfolio Management",
    "USR_DEPARTMENT_NAME_Customer Operations_ South",
    "USR_EMP_TYPE_Employee"
]
}
],
"user": {
    "displayName": "John Doe",
    "hrData": [
        {
            "title": "Job Code Name",
            "id": "JOB CODENAME",
            "value": "Business Representative"
        },
        {
            "title": "Line of Business",
            "id": "LINE OF BUSINESS",
            "value": "Portfolio Management"
        },
        {
            "title": "Department",
            "id": "DEPARTMENT",
            "value": " South"
        }
    ],

```

```

    {
      "title": "Employee Type",
      "id": "EMPTYTYPE",
      "value": "Employee"
    }
  ]
},
"entitlementsCount": 2,
"entitlementsRemainingCount": 9,
"lastEntitlementId": "ent4"
}

```

GET /api/userDetails/decisions

GET /api/userDetails/decisions

Get the current entitlement decisions for the user [Supervisor, Ent Owner, App Owner, Admin].

Endpoint

/api/userDetails/decisions

Authorization

<Bearer Token JWT-value> OR <API-KEY>

Query Parameters

Parameter	Type	Description
user	string	User ID (required)
filter	object	Filter to add (single property shown below)

Filter Query Object Properties

Parameter	Type	Description
datasinkStatus	string	Datasink status filter ('ack' or 'nack')

Parameter	Type	Description
timestampThresholds	timestamp Thresholds object	Timestamp threshold object (available properties below)

timestampThresholds Object Properties

Parameter	Type	Description
gt	string	Greater than timestamp (format: yyyy-mm-ddThh:mm:ss.SSSZ). Cannot be present with gte .
gte	string	Greater than or equal timestamp (format: yyyy-mm-ddThh:mm:ss.SSSZ). Cannot be present with gt .
lt	string	Less than timestamp (format: yyyy-mm-ddThh:mm:ss.SSSZ). Cannot be present with lte .
lte	string	Less than or equal timestamp (format: yyyy-mm-ddThh:mm:ss.SSSZ). Cannot be present with le .

Example Request (DatasinkStatus Filter)

```
curl -k -X GET \
  'datasinkStatus=nack' \
  -H 'Authorization: Bearer <token value>' \ <or> -H 'X-API-KEY: <api key value>' \
  -H 'Content-Type: application/json'
```

Example Response (DatasinkStatus Filter)

```
{
  "decisions": [
    {
      "user": "john.doe",
```

```

    "entitlement": "ent_1",
    "is_certified": false,
    "is_revoked": false,
    "is_processed": false,
    "is_archived": false,
    "author": "jane.smith",
    "author_name": "Jane Smith",
    "author_type": "Zoran Admin",
    "reason": null,
    "last_updated": "2022-01-11T19:48:17.195Z",
    "datasink_status": "nack",
    "usr_name": "John Doe",
    "ent_name": "Entitlement 1",
    "app_id": "Gateway",
    "app_name": "Gateway",
    "usr_manager_id": "john.smith",
    "conf": 0.75,
    "freq": 4,
    "freqUnion": 3
  }
]
}

```

POST /api/userDetails/decisions

POST /api/userDetails/decisions

Update entitlement decisions for users. [Supervisor, Ent Owner, App Owner, Admin]

Endpoint

/api/userDetails/decisions

Authorization

<Bearer Token JWT-value>

Request Body Parameters

Parameter	Type	Description
-----------	------	-------------

Parameter	Type	Description
assignments	array of assignment objects	List of assignments affected by the decision (available properties listed below)(required)
is_certified	boolean	Certification decision
is_revoked	boolean	Revoke decision
is_requested	boolean	Decision is processed
reason	string	Reason for decision
datasink_status	string	Datasink status ('ack' or 'nack')

Assignments Object Properties

Parameter	Type	Description
user	string	User ID (required)
entitlements	string array	List of entitlement ID's (required)

Body

```
{
  "assignments": [
    {
      "user": "string",
      "entitlements": [
        "string"
      ]
    }
  ],
  "is_certified": true,
  "is_revoked": true,
  "is_requested": true,
  "is_processed": true,
  "reason": "string",
  "datasink_status": "nack"
}
```

Example Request

```
curl -k -X POST \
  "https://autoid-
  api.forgerock.com/api/userDetails/decisions" \
  -H 'Authorization: Bearer <token-value>' \
  -H "accept: /" -H "Content-Type: application/json" \
  --data-raw '{
    "assignments": [
      {
        "user": "john.doe",
        "entitlements": [
          "ABC",
          "DEFFF"
        ]
      }
    ],
    "is_certified": true,
    "is_revoked": false,
    "is_requested": false,
    "is_processed": false,
    "reason": "string",
    "datasink_status": "nack"
  }'
```

Example Response

```
{
  "status": 200
}
```

POST /api/userDetails/hrData

POST /api/userDetails/hrData

Get a user's HR data. [User, Supervisor, Ent Owner, App Owner, Admin]

Endpoint

```
/api/userDetails/hrData
```

Authorization

```
<Bearer Token JWT-value>
```

Headers

```
Content-Type      application/json
```

Body

```
{  
  "employeeId": "john.doe"  
}
```

Example Request

```
curl --request POST "https://autoid-  
api.forgerock.com/api/userDetails/hrData" \  
--header "Content-Type: application/json" \  
--header "Authorization: Bearer <token>" \  
--data-raw '{  
  "employeeId": "john.doe"  
}'
```

Example Response

```
{  
  "user": [  
    {  
      "id": "USER_NAME",  
      "title": "User Name",  
      "value": "john.doe"  
    },  
    {  
      "id": "CHIEF",  
      "title": "Chief",  
      "value": "Yes"  
    }  
  ]  
}
```

```
    },
    {
      "id": "CITY",
      "title": "City",
      "value": "Toledo"
    },
    {
      "id": "USER_DISPLAY_NAME",
      "title": "User Display Name",
      "value": "John Doe"
    },
    {
      "id": "EMPLOYEE_TYPE",
      "title": "Employee Type",
      "value": "Employee"
    },
    {
      "id": "MANAGER",
      "title": "Manager",
      "value": "the.manager"
    }
  ],
  "displayName": "John Doe"
}
```

POST /api/userDetails/search

POST /api/userDetails/search

Search for users by name and with applied filters. [Executive, Supervisor, App Owner, Admin]

Endpoint

```
/api/userDetails/search
```

Authorization

```
<Bearer Token JWT-value>
```

Headers

```
Content-Type    application/json
```

Body

```
{  
  "username": "john.doe"  
}
```

Example Request

```
curl --request POST "https://autoid-  
api.forgerock.com/api/userDetails/search" \  
--header "Content-Type: application/json"  
--data-raw '{  
  "username": "john.doe"  
}'
```

Example Response

```
{  
  "values": [  
    {  
      "user": "john.doe",  
      "isapplicationowner": "false",  
      "isentitlementowner": "false",  
      "issupervisor": "false",  
      "userdisplayname": "John Doe"  
    }  
  ]  
}
```

POST /api/userDetails/ent/autoprovision

POST /api/userDetails/ent/autoprovision

Get user's entitlements for autoprovisioning. [Admin]

Endpoint

```
/api/userDetails/ent/autoprovision
```

Authorization

```
<Bearer Token JWT-value>
```

Headers

```
Content-Type      application/json
```

Body

```
{  
  "user": "john.doe"  
}
```

Example Request

```
curl --request POST "https://autoid-  
api.forgerock.com/api/userDetails/ent/autoprovision" \  
--header "Content-Type: application/json" \  
--header 'Authorization: Bearer <token>' \  
--data-raw '{  
    "user": "john.doe"  
}'
```

Example Response

```
{  
  "usr_id": "string",  
  "usr_name": "string",  
  "ents": [  
    {
```

```
"ent_id": "string",
"ent_name": "string",
"ent_attribute": "string",
"ent_risk_level": "string",
"score": 0,
"freq": 0,
"freunion": 0,
"justification": [
  {
    "title": "string",
    "value": "string"
  }
],
"app_id": "string",
"app_name": "string"
}
],
"cursor": "string"
}
```

No links

POST /api/userDetails/autoAction

POST /api/userDetails/autoAction

Get the list of entitlements for a user or list of users for an entitlement to provision, revoke, or certify. [Admin]

Endpoint

```
/api/userDetails/autoAction
```

Authorization

```
<Bearer Token JWT-value>
```

Headers

```
Content-Type      application/json
```

Body

```
{
  "action": "addAccess",
  "usrId": "john.doe",
  "entId": "entitlement_1",
  "thresholds": {
    "gte": 0,
    "gt": 0,
    "lte": 0,
    "lt": 0
  },
  "cursor": "string"
}
```

Example Request

```
curl --request POST "https://autoid-
api.forgerock.com/api/userDetails/autoAction" \
--header "Content-Type: application/json" \
--header "Authorization: Bearer <token>" \
--data-raw '{
  "action": "addAccess",
  "usrId": "john.doe",
  "entId": "entitlement_1",
  "thresholds": {
    "gte": 0,
    "gt": 0,
    "lte": 0,
    "lt": 0
  },
  "cursor": "string"
}'
```

POST /api/userDetails/drivingFactor

POST /api/userDetails/drivingFactor

Get the driving factor data. [User, Supervisor, Ent Owner, App Owner, Admin]

Endpoint

```
/api/userDetails/drivingFactor
```

Authorization

```
<Bearer Token JWT-value>
```

Headers

```
Content-Type      application/json
```

Params

```
{  
  "entitlement": "entitlement1"  
}
```

Example Request

```
curl --request POST "https://autoid-  
api.forgerock.com/api/userDetails/drivingFactor" \  
--header "Content-Type: application/json" \  
--header "Authorization: Bearer <token>" \  
--data-raw '{  
  "entitlement": "entitlement1"  
}'
```

Example Request

```
[  
  {  
    "ent": "ent1",  
    "attribute": {  
      "title": "Chief",
```

```
    "value": "No"
  },
  "count": 3,
  "rawAttribute": "CHIEF_YES_NO_No"
},
{
  "ent": "ent1",
  "attribute": {
    "title": "City",
    "value": "Tacoma"
  },
  "count": 5,
  "rawAttribute": "CITY_Tacoma"
}
]
```

POST /api/userDetails/distinct

POST /api/userDetails/distinct

Get a list of all users.

Endpoint

```
/api/userDetails/distinct
```

Authorization

```
<Bearer Token JWT-value>
```

Headers

```
Content-Type      application/json
```

Params

```
pageSize number (optional)  Specify the number of
assignments to return per page
```

cursor (optional) String (Indicator on where to start a 2+ page list)
<searchable-attribute> Any searchable attribute specified in the Identities Entity Definitions page

Body

```
{
  "pageSize": 2,
  "cursor": "eyJ1c3JfaWQiOiJtYXJ5J5LmRvbm92YW4ifQ==",
  "cost_center": "0P"
}
```

Example Request

```
curl --request POST "https://autoid-
api.forgerock.com/api/userDetails/distinct" \
--header "Content-Type: application/json" \
--header "Authorization: Bearer <token>"
--data-raw {
  "pageSize": 2,
  "cursor": "eyJ1c3JfaWQiOiJtYXJ5J5LmRvbm92YW4ifQ==",
  "cost_center": "0P"
}
```

Example Response

```
[
  {
    "usr_id": "john.doe",
    "usr_name": "John Doe",
    "usr_manager_id": "jane.smith",
    "cost_center": "0P_TT4"
  }
]
```

Single view with application

IMPORTANT

This endpoint has been deprecated in this release and will be removed in a future release.

NOTE

This endpoint has been updated in this release to accept only string values for all fields.

The following is an Autonomous Identity single view with applications endpoint:

POST employees

POST employees

Endpoint

```
/api/singleViewWithApp/employees
```

Authorization

```
<Bearer Token JWT-value>
```

Body

```
{  
    "employeeId": "elizabeth.saiz",  
    "includeLastAccessed": "true",  
    "pageSize": "5"  
}
```

Example Request

```
curl --location --request POST  
'/api/singleViewWithApp/employees' \  
--header 'Content-Type: application/json' \  

```



```
--data-raw '{
    "employeeId": "elizabeth.saiz",
    "includeLastAccessed": "true",
    "pageSize": "5"
}'
```

Example Response

```
{
  "high": 0,
  "medium": 1,
  "low": 1,
  "avg_score": 0.25,
  "app_name": "",
  "app_id": "",
  "entitlement_name": "",
  "high_risk": null,
  "userEntt": [
    {
      "user": "elizabeth.saiz",
      "entitlement": "192aed21-a7d1-40c3-87a3-9dfa4a3d21f5",
      "app_id": "null",
      "app_name": "test3",
      "entitlement_name": "null",
      "freq": null,
      "frequentunion": null,
      "high_risk": "null",
      "justification": [],
      "score": 0.1,
      "user_name": "alpha"
    },
    {
      "user": "elizabeth.saiz",
      "entitlement": "36bad416-d42c-47c2-991e-623aa3833028",
      "app_id": "null",
      "app_name": "test6",
      "entitlement_name": "null",
      "freq": null,
      "frequentunion": null,
      "high_risk": "null",
      "justification": [],

```

```
        "score": 0.4,  
        "user_name": "vce"  
    }  
],  
"user": "elizabeth.saiz",  
"entitlementsCount": 14,  
"entitlementsRemainingCount": 10,  
"lastEntitlementId": "36bad416-d42c-47c2-991e-  
623aa3833028"  
}
```

Access Control

The following are Autonomous Identity access control endpoints:

GET /api/userDetails/decisions

GET /api/userDetails/decisions

Get the current entitlement decisions for the user. [Supervisor, Ent Owner, App Owner, Admin]

Endpoint

```
/api/userDetails/decisions
```

Authorization

```
<Bearer Token JWT-value> OR <API-KEY>
```

Param

```
user=john.doe
```

Query Parameters

Parameter	Type	Description
-----------	------	-------------

Parameter	Type	Description
user	string	User ID (required)
filter	object	Filter to add (single property shown below)

Filter Query Object Properties

Parameter	Type	Description
datasinkStatus	string	Datasink status filter ('ack' or 'nack')
timestampThresholds		Timestamp threshold object

timestampThresholds Object Properties

Parameter	Type	Description
gt	string	Greater than timestamp (format: yyyy-mm-ddThh:mm:ss.SSSZ). Cannot be present with gte .
gte	string	Greater than or equal timestamp (format: yyyy-mm-ddThh:mm:ss.SSSZ). Cannot be present with gt .
lt	string	Less than timestamp (format: yyyy-mm-ddThh:mm:ss.SSSZ). Cannot be present with lte .
lte	string	Less than or equal timestamp (format: yyyy-mm-ddThh:mm:ss.SSSZ). Cannot be present with le .

Example Request (DatasinkStatus Filter)

```
curl -k -X GET \
  'datasinkStatus=nack' \
  -H 'Authorization: Bearer <token value>' \ <or> -H 'X-API-KEY: <api key value>' \
  -H 'Content-Type: application/json'
```

Example Response (DatasinkStatus Filter)

```
{
  "decisions": [
    {
      "user": "john.doe",
      "entitlement": "ent_1",
      "is_certified": false,
      "is_revoked": false,
      "is_processed": false,
      "is_archived": false,
      "author": "jane.smith",
      "author_name": "Jane Smith",
      "author_type": "Zoran Admin",
      "reason": null,
      "last_updated": "2022-01-11T19:48:17.195Z",
      "datasink_status": "nack",
      "usr_name": "John Doe",
      "ent_name": "Entitlement 1",
      "app_id": "Gateway",
      "app_name": "Gateway",
      "usr_manager_id": "john.smith",
      "conf": 0.75,
      "freq": 4,
      "freqUnion": 3
    }
  ]
}
```

POST /api/userDetails/decisions

POST /api/userDetails/decisions

Update entitlement decisions for users. [Supervisor, Ent Owner, App Owner, Admin]

Endpoint

```
/api/userDetails/decisions
```

Authorization

<Bearer Token JWT-value> OR <API-KEY>

Request Body Parameters

Parameter	Type	Description
assignments	array of assignment objects	List of assignments affected by the decision (available properties listed below)(required)
is_certified	boolean	Certification decision
is_revoked	boolean	Revoke decision
is_requested	boolean	Decision is processed
reason	string	Reason for decision
datasink_status	string	Datasink status ('ack' or 'nack')

Assignments Object Properties

Parameter	Type	Description
user	string	User ID (required)
entitlements	string array	List of entitlement ID's (required)

Body

```
{
  "assignments": [
    {
      "user": "string",
      "entitlements": [
        "string"
      ]
    }
  ],
  "is_certified": true,
  "is_revoked": true,
  "is_requested": true,
```

```
"is_processed": true,
"reason": "string",
"datasink_status": "nack"
}
```

Example Request

```
curl --request POST "https://autoid-
api.forgerock.com/api/userDetails/decisions" \
-H "accept: /" -H "Content-Type: application/json" \
--data-raw '{
  "assignments": [
    {
      "user": "string",
      "entitlements": [
        "string"
      ]
    }
  ],
  "is_certified": true,
  "is_revoked": true,
  "is_requested": true,
  "is_processed": true,
  "reason": "string",
  "datasink_status": "nack"
}'
```

Example Response

```
{
  "status": 200
}
```

POST /api/rules/decision

POST /api/rules/decision

Update rule decisions. [Supervisor, Ent Owner, App Owner, Admin]

Endpoint

/api/rules/decision

Authorization

<Bearer Token JWT-value>

Request Body Parameters

Parameter	Type	Description
rules	array of rules objects	List of rules affected by the decision (available properties listed below) (required)
is_autocertify	boolean	Auto-Certification decision (required)
is_autorequest	boolean	Auto-Request decision (required)
autocertify_reason	boolean	Auto-Certification reason (required)
autorequest_reason	boolean	Auto-Request reason (required)
datasink_status	string	Datasink status ('ack' or 'nack')

Rule Object Properties

Parameter	Type	Description
entitlement	string	Entitlement ID (required)
justification	string array	List of raw justifications (required)

Body

```
{
  "rules": [
    {
      "entitlement": "string",
      "justification": [
        "string"
      ]
    }
  ]
}
```

```
    ]
  }
],
"is_autocertify": true,
"is_autorequest": true,
"autocertify_reason": "string",
"autorequest_reason": "string"
}
```

Example Request

```
curl -k -X POST \
  "https://autoid-api.forgerock.com/api/rules/decision" \
  -H 'Authorization: Bearer <token-value>' \
  -H "accept: /" -H "Content-Type: application/json" \
  --data-raw '{
"rules": [
  {
    "entitlement": "Ent_1",
    "justification": [
      "0C_CHIEF_YES_NO_Yes",
      "0C_JOBCODE_NAME_Service Representative II",
      "0C_MANAGER_NAME_John_Doe",
      "0C_USR_EMP_TYPE_Non-Employee"
    ]
  }
],
"is_autocertify": true,
"is_autorequest": false,
"autocertify_reason": "Goodbye, world.",
"autorequest_reason": "Hello, world."
}'
```

Example Response

```
Status 204: No Content
```

Applications

The following are Autonomous Identity applications view endpoints:

GET /api/applications

GET /api/applications

Get a list of applications and stats for an Application Owner. [App Owner, Admin]

Endpoint

```
/api/applications
```

Authorization

```
<Bearer Token JWT-value>
```

Params

```
ownerId (optional)  derick.hui  
cursor (optional)  string (Indicator on where to start a  
2+ page list)
```

Example Request

```
curl --request GET "https://autoid-  
api.forgerock.com/api/applications?ownerId=derick.hui" \  
--header "Content-Type: application/json"
```

Example Response

```
{  
  "cursor": "string",  
  "total_applications": 0,  
  "total_entitlements": 0,  
  "total_assignments": 0,  
  "applications": [  
    {  
      "app_id": "string",
```

```
    "app_name": "string",
    "high": 0,
    "medium": 0,
    "low": 0,
    "avg": 0
  }
]
}
```

POST /api/applications/{appId}

POST /api/applications/{appId}

Get a list of entitlements and stats for a selected application. [App Owner, Admin]

Endpoint

```
/api/applications/{appId}
```

Authorization

```
<Bearer Token JWT-value>
```

Params

appId (required)	app_1
cursor (optional)	string (Indicator on where to start a 2+ page list)

Body

```
{
  "filters": [
    {
      "type": "user",
      "attribute": "city",
      "value": ["Seattle", "Denver"]
    },
  ],
}
```

```
{
  "type": "user",
  "attribute": "line_of_business",
  "value": ["Distribution Operations"]
}
]
```

Example Request

```
curl --request POST "https://autoid-
api.forgerock.com/api/applications/app_1" \
--header "Content-Type: application/json" \
--header "Authorization: Bearer <token>" \
--data-raw '{
  "filters": [
    {
      "type": "user",
      "attribute": "city",
      "value": ["Seattle", "Denver"]
    },
    {
      "type": "user",
      "attribute": "line_of_business",
      "value": ["Distribution Operations"]
    }
  ]
}'
```

Example Response

```
{
  "cursor": "string",
  "total_entitlements": 0,
  "total_users": 0,
  "total_rules": 0,
  "entitlements": [
    {
      "ent": "string",
      "ent_name": "string",
      "high": 0,

```

```
        "medium": 0,  
        "low": 0,  
        "avg": 0  
    }  
]  
}
```

POST /api/applications/{appId}/assignments

POST /api/applications/{appId}/assignments

Get filterable user-entitlement assignment and decision data for a specific application. [App Owner, Admin]

Endpoint

```
api/applications/{appId}/assignments
```

Authorization

```
<Bearer Token JWT-value>
```

Params

appId (required)	app_1
user	string
cursor (optional) 2+ page list)	string (Indicator on where to start a
sortBy	string
sortDir	string

Body

```
{  
  "filters": [  
    {  
      "type": "user",  
      "attribute": "city",
```

```

    "value": [
      "Seattle",
      "Denver"
    ]
  },
  {
    "type": "user",
    "attribute": "line_of_business",
    "value": [
      "Distribution Operations"
    ]
  }
]
}

```

Example Request

```

curl --request POST "https://autoid-
api.forgerock.com/api/applications/app_1/assignments" \
--header "Content-Type: application/json" \
--header "Authorization: Bearer <token>" \
--data-raw '{
  "filters": [
    {
      "type": "user",
      "attribute": "city",
      "value": [
        "Seattle",
        "Denver"
      ]
    },
    {
      "type": "user",
      "attribute": "line_of_business",
      "value": [
        "Distribution Operations"
      ]
    }
  ]
}'

```

Example Response

```
{
  "cursor": "string",
  "total_users": 0,
  "total_entitlements": 0,
  "total_assignments": 0,
  "assignments": [
    {
      "ent": "string",
      "ent_name": "string",
      "confidence": 0,
      "user_id": "string",
      "user_name": "string",
      "isCertified": true,
      "dateCertified": "2021-04-14T19:10:39.178Z",
      "isRevoked": true,
      "dateRevoked": "2021-04-14T19:10:39.178Z",
      "isRequested": true,
      "dateRequested": "2021-04-14T19:10:39.178Z",
      "isProcessed": true,
      "approvalAuthor": {
        "id": "string",
        "name": "string"
      }
    }
  ]
}
```

GET /api/applications/search

GET /api/applications/search

Search all applications. [App Owner, Admin]

Endpoint

```
/api/applications/search
```

Authorization

```
<Bearer Token JWT-value>
```

Params

```
by          appOwner or enttOwner
user       user ID
q          Search query string
```

Example Request

```
curl --request GET "https://autoid-
api.forgerock.com/api/applications/search" \
--header "Content-Type: application/json"
```

Example Response

```
{
  "values": [
    {
      "app_id": "string",
      "app_name": "string"
    }
  ]
}
```

Entitlements

The following are Autonomous Identity filtering by entitlements endpoints:

GET /api/entitlements/search

GET /api/entitlements/search

Search for entitlements by name and with applied filters. [Ent Owner, App Owner, Admin]

Endpoint

```
/api/entitlements/search?q=QueryString
```

Authorization

```
<Bearer Token JWT-value>
```

Params

```
by      appOwner or enttOwner
user    user ID
q       Search query string (required)
appId   Application ID to use as a filter
```

Example Request

```
curl --location --request GET 'https://autoid-
api.forgerock.com/api/entitlements/search?
by=enttOwner&user=john.doe&q=WEB&appId=Salesforce' \
--header 'Content-Type: application/json'
```

Example Response

```
{
  "values": [
    {
      "id": "string",
      "app_id": "string",
      "app_name": "string",
      "entt_name": "string"
    }
  ]
}
```

POST /api/entitlements/stats

POST /api/entitlements/stats

Get data for entitlements view. [Supervisor, Ent Owner, Admin]

Endpoint

```
/api/entitlements/stats?  
by=supervisor/entitlementOwner/admin
```

Authorization

```
<Bearer Token JWT-value>
```

Params

```
by      supervisor, roleOwner
```

Body

```
{  
  "ownerId": "timothy.slack",  
  "isHighRiskOnly": true,  
  "isMediumLowRiskOnly": false,  
  "isUserEntitlementsIncluded": true,  
  "filters": [{  
    "type": "app_id",  
    "group": "criticality",  
    "value": "Essential"  
  }]  
}
```

Example Request

```
curl --location --request POST 'https://autoid-  
api.forgerock.com/api/entitlements/stats?by=supervisor' \  
--header 'content-type: application/json' \  
--data-raw '{  
  "ownerId": "timothy.slack",  
  "isHighRiskOnly": true,  
  "isMediumLowRiskOnly": false,  
  "isUserEntitlementsIncluded": true,  
  "filters": [{  
    "type": "app_id",
```

```
        "group": "criticality",
        "value": "Essential"
    }
}
```

Example Response

```
{
  "total_entitlements": 0,
  "total_subordinates": 0,
  "unscoredEntitlements": 0,
  "scoredEntitlements": 0,
  "usersWithNoEntitlement": 0,
  "usersWithNoScoredEntitlement": 0,
  "distinct_apps": [
    {
      "app_id": "string",
      "app_name": "string",
      "low": 0,
      "medium": 0,
      "high": 0
    }
  ],
  "users": [
    {
      "user": "string",
      "user_name": "string",
      "high": 0,
      "medium": 0,
      "low": 0,
      "avg": "string"
    }
  ],
  "entitlements": [
    {
      "entitlement": "string",
      "entitlement_name": "string",
      "app_id": "string",
      "high_risk": "string",
      "high": 0,
      "medium": 0,
      "low": 0,
      "avg": "string"
    }
  ]
}
```

```
}  
  ]  
}
```

GET /api/entitlements/id/{id}

GET /api/entitlements/id/{id}

Get entitlement details. [User, Supervisor, Ent Owner, App Owner, Admin]

Endpoint

```
/api/entitlements/id/{id+}
```

Authorization

```
<Bearer Token JWT-value>
```

Params

```
by      entitlement ID
```

Example Request

```
curl --request GET "https://autoid-  
api.forgerock.com/api/entitlements/id/1234" \  
--header "Content-Type: application/json"
```

Example Response

```
{  
  "entitlement_name": "string",  
  "scores": {  
    "avg": 0,  
    "high": 0,  
    "medium": 0,  
  }  
}
```

```

    "low": 0
  },
  "drivingFactors": [
    {
      "attribute": {
        "id": "string",
        "title": "string",
        "value": "string"
      },
      "count": 0
    }
  ],
  "userScores": [
    {
      "score": 0,
      "count": 0
    }
  ],
  "users": [
    {
      "user": "string",
      "user_name": "string",
      "app_id": "string",
      "freq": 0,
      "frequion": 0,
      "justification": [
        {
          "title": "string",
          "value": "string"
        }
      ],
      "rawJustification": [
        "string"
      ],
      "score": 0
    }
  ]
}

```

GET /api/entitlements/unscored

GET /api/entitlements/unscored

Get unscored entitlements and users for a given Supervisor or Entitlement Owner ID.
[Supervisor, Ent Owner, Admin]

Endpoint

```
/api/entitlements/unscored
```

Authorization

```
<Bearer Token JWT-value>
```

Params

```
by      supervisor, entitlement owner  
user    supervisor or entitlement owner user ID
```

Example Request

```
curl --request GET "https://autoid-  
api.forgerock.com/api/entitlements/unscored?  
by=supervisor&user=1234" \  
--header "Content-Type: application/json"
```

GET /api/entitlements/distinct

GET /api/entitlements/distinct

Get a list of all entitlements.

Endpoint

```
/api/entitlements/distinct
```

Authorization

```
<Bearer Token JWT-value>
```

Example Request

```
curl --location --request GET 'https://autoid-  
api.forgerock.com/api/entitlements/distinct' \  
--header 'Content-Type: application/json' \  
--header 'Authorization: Bearer <token>'
```

Example Response

```
[  
  {  
    "ent_id": "AccessType : XMLP_ADMIN",  
    "ent_name": "AccessType : XMLP_ADMIN",  
    "ent_owner_id": "julie.yee",  
    "app_id": "Salesforce",  
    "ent_criticality": "Non-Essential",  
    "ent_risk_level": "Medium"  
  }  
]
```

GET /api/entitlements/recommendations

GET /api/entitlements/recommendations

Get a list of entitlement recommendations for a given set of user attributes.

Endpoint

```
/api/entitlements/recommendations
```

Authorization

```
<Bearer Token JWT-value>
```

Body

```

{
  "confidenceThreshold": 0.1,
  "maxResults": 1000,
  "offset": 200,
  "userAttributes": [
    "0E_USR_MANAGER_ID_gregory.suhr",
    "13_USR_DEPARTMENT_NAME_Facilities Area
A",
    "0C_CHIEF_YES_NO_No",
    "0C_MANAGER_NAME_Gregory Suhr",
    "0C_USR_EMP_TYPE_Employee",
    "13_USR_DEPARTMENT_NAME_Wireless
Operations"
  ]
}

```

Example Request

```

curl --request GET "https://autoid-
api.forgerock.com/api/entitlements/recommendations" \
--header "Content-Type: application/json" \
--header "Authorization: Bearer <token>" \
--data-raw '{
  "confidenceThreshold": 0.1,
  "maxResults": 1000,
  "offset": 200,
  "userAttributes": [
    "0E_USR_MANAGER_ID_gregory.suhr",
    "13_USR_DEPARTMENT_NAME_Facilities Area A",
    "0C_CHIEF_YES_NO_No",
    "0C_MANAGER_NAME_Gregory Suhr",
    "0C_USR_EMP_TYPE_Employee",
    "13_USR_DEPARTMENT_NAME_Wireless Operations"
  ]
}'

```

Example Response

```

[
  {
    "attributes": [

```

```

        "0C_CHIEF_YES_NO_No",
        "0E_USR_MANAGER_ID_gregory.suhr"
    ],
    "entitlement": "06_ENT_ID_WEB_user_WEB RCQ Flare NonIT
Distribution_II",
    "confidence": 0.14,
    "frequency": 22
},
{
    "attributes": [
        "0C_MANAGER_NAME_Gregory Suhr",
        "13_USR_DEPARTMENT_NAME_Facilities Area A"
    ],
    "entitlement": "06_ENT_ID_Web_tildeNon-security plus",
    "confidence": 0.14,
    "frequency": 28
},
]

```

Assignments

The following endpoint has been added to support the extraction of assignments. New APIs introduced in this release are marked with .

POST /api/assignments

POST /api/assignments

Get a list of all assignments or filtered assignments when the following optional filtering is sent as a JSON request body.

The endpoint requires a valid API key passed in a `X-API-KEY` header for authorization (refer to [Generate an API key](#)) or an authorized admin-level bearer token.

Endpoint

+

/api/assignments

Headers

+

Content-Type **application/json**

Body Parameters

Parameter	Type	Description
cursor	string	Cursor to send for the next page of assignments (the response returns null if there are no more pages)
pageSize	integer	Number of assignments to return per page
ent_id	string	Entitlement ID to filter by
usr_id	string	User ID to filter by
app_id	string	Application ID to filter by

Example Request

+

```
curl -k -X POST \  
https://autoid-ui.forgerock.com/api/assignments↗ \  
-H 'X-API-KEY: <api key value>' \  
-H 'Content-Type: application/json' \  
-d '{  
  "pageSize": 20,  
  "cursor":  
  "WyJhYXJvbi5maXNjaGVyIiwVVCX3VzZXJfU2hhcmVkaXRfQURNSU  
5fSUKiXQ=="  
'
```

Example Response

+

```

{
  "cursor":
  "WyJhYXJvbi5mb2x0eiIsIldlY19TZXJ2aWNlQW5hbHl0aWNzIDogS1BJIE
  FnZW50IGFuZCBQb3dlciBBY2Nlc3NfSUKiXQ==",
  "assignments": [
    {
      "ent_id": "WEB_user_Web_Local Access 32
All_II_Europe",
      "usr_id": "aaron.fischer",
      "score": null,
      "justification": []
    },
    {
      "ent_id": "WEB_user_Web_Shared_Edit_ADMIN_Europe",
      "usr_id": "aaron.fischer",
      "score": null,
      "justification": []
    },
    {
      "ent_id": "WEB_user_Web_WEB RCQ Flare NonIT
Distribution_Europe",
      "usr_id": "aaron.fischer",
      "score": 0.98,
      "justification": [
        {
          "id": "CHIEF_YES_NO",
          "title": "chief_yes_no",
          "value": "Yes"
        },
        {
          "id": "USR_DEPARTMENT_NAME",
          "title": "USR_DEPARTMENT_NAME",
          "value": "Information Systems 1"
        }
      ]
    },
    {
      "ent_id": "Web_Flare NonIT Distribution",
      "usr_id": "aaron.fischer",
      "score": 0.6,
      "justification": [
        {
          "id": "CITY",
          "title": "city",
          "value": "Jacksonville"
        }
      ]
    }
  ]
}

```

```
    },
    {
      "id": "USR_EMP_TYPE",
      "title": "usr_emp_type",
      "value": "Employee"
    },
    {
      "id": "LINE_OF_BUSINESS",
      "title": "line_of_business",
      "value": "Strategy and Policy"
    }
  ]
}
```

Rules

The following are Autonomous Identity rules endpoints:

GET /api/rules/info

GET /api/rules/info

List information and statistics regarding available rules. [Ent Owner, App Owner, Admin]

Endpoint

```
/api/rules/info
```

Authorization

```
<Bearer Token JWT-value>
```

Params

```
by      enttowner, appOwner
```

```
user      patrick.murphy
```

Example Request

```
curl --request GET "https://autoid-  
api.forgerock.com/api/rules/info?  
by=appOwner&user=patrick.murphy" \  
--header "Content-Type: application/json"
```

Example Response

```
{  
  "countRules": 0,  
  "countAssignments": 0,  
  "countApplications": 0,  
  "applications": [  
    {  
      "app_id": "string",  
      "app_name": "string",  
      "countAssignments": 0,  
      "low": 0,  
      "medium": 0,  
      "high": 0  
    }  
  ]  
}
```

GET /api/rules

GET /api/rules

List the available rules for a user [Ent Owner, App Owner, Admin]. You can filter by time period by using greater than and/or less than date-times.

Endpoint

```
/api/rules/
```

Authorization

<Bearer Token JWT-value> OR <API-KEY>

Query Parameters

Parameter	Type	Description
by	string	User type to apply when searching rules: entt0wner , app0wner
user	string	User ID when applying <i>by</i> filters (required if using "by")
cursor	string	Position to start a 2+ page list.
pageSize	number	Number of records per page to retrieve.
filter	filter object	Additional filters to apply (refer to properties below).

Filter Query Object Properties

Parameter	Type	Description
lowConfidence	boolean	Low confidence scores only.
medConfidence	boolean	Medium confidence scores only.
highConfidence	boolean	High confidence scores only.
app_id	string array	Array of application IDs.
autoCertify	boolean	Auto-certified only.
autoRequest	boolean	Auto-requested only.
entitlement	string	Entitlement ID
datasinkStatus	string	Datasink status filter ('ack' or 'nack')
timestampThresholds	object	Timestamp threshold object (available properties below)

timestampThresholds Object Properties

Parameter	Type	Description
-----------	------	-------------

Parameter	Type	Description
gt	string	Greater than timestamp (format: yyyy-mm-ddThh:mm:ss.SSSZ). Cannot be present with gte .
gte	string	Greater than or equal timestamp (format: yyyy-mm-ddThh:mm:ss.SSSZ). Cannot be present with gt .
lt	string	Less than timestamp (format: yyyy-mm-ddThh:mm:ss.SSSZ). Cannot be present with lte .
lte	string	Less than or equal timestamp (format: yyyy-mm-ddThh:mm:ss.SSSZ). Cannot be present with le .

Example Request (Datasink status filter)

```
curl -k -X GET \
  'datasinkStatus=ack' \
  -H 'Authorization: Bearer <token value>' <OR> -H 'X-API-KEY: <api-key-value>' \
  -H 'Content-Type: application/json'
```

Example Response (Datasink status filter)

```
{
  "cursor": null,
  "totalRulesCount": 1,
  "rules": [
    {
      "entitlement":
      {
        "ent_id": "Cognos EDI Reporting",
        "ent_owner_id": "david.elliott",
        "ent_criticality": "Essential",
        "ent_risk_level": "High",
```

```

    "ent_name": "Cognos EDI Reporting",
    "app_id": "SAP"
  },
  "app":
  {
    "app_criticality": "Essential",
    "app_name": "SAP",
    "app_owner_id": "derick.hui",
    "app_risk_level": "High",
    "app_id": "SAP"
  },
  "justification": [
    {
      "id": "CHIEF_YES_NO",
      "title": "Chief?",
      "value": "No"
    },
    {
      "id": "MANAGER_NAME",
      "title": "Manager Name",
      "value": "Patrick Gardner"
    },
    {
      "id": "USR_EMP_TYPE",
      "title": "Employee Type",
      "value": "Employee"
    },
    {
      "id": "USR_DEPARTMENT_NAME",
      "title": "User department Name",
      "value": "General Office"
    }
  ],
  "rawJustification": [
    "0C_CHIEF_YES_NO_No",
    "0C_MANAGER_NAME_Patrick Gardner",
    "0C_USR_EMP_TYPE_Employee",
    "13_USR_DEPARTMENT_NAME_General Office"
  ],
  "assignees": [
    {
      "id": "gordon.choy",
      "name": "Gordon Choy"
    },
    {

```

```

        "id": "jennifer.kanenaga",
        "name": "Jennifer Kanenaga"
    },
    {
        "id": "lawrence.nicholls",
        "name": "Lawrence Nicholls"
    },
    {
        "id": "roel.dilag",
        "name": "Roel Dilag"
    },
    {
        "id": "salvatore.taormina",
        "name": "Salvatore Taormina"
    }
],
"confidence": 1,
"countUnassigned": 0,
"countAssigned": 5,
"isAutoCertify": true,
"autoCertifyDate": "2021-10-01T19:01:31.567Z",
"isAutoRequest": true,
"autoRequestDate": "2021-10-01T19:01:31.567Z",
"approvalAuthor":
{
    "id": "bob.rodgers",
    "name": "Bob Rodgers"
},
"requestApprovalReason": "Test",
"certifyApprovalReason": "Test",
"datasink_status": "ack"
}
]
}

```

POST /api/rules/decision

POST /api/rules/decision

Update rule decisions. [Supervisor, Ent Owner, App Owner, Admin]

Endpoint

/api/rules/decision

Authorization

<Bearer Token JWT-value>

Request Body Parameters

Parameter	Type	Description
rules	array of rules objects	List of rules affected by the decision (available properties listed below) (required)
is_autocertify	boolean	Auto-Certification decision (required)
is_autorequest	boolean	Auto-Request decision (required)
autocertify_reason	boolean	Auto-Certification reason (required)
autorequest_reason	boolean	Auto-Request reason (required)
datasink_status	string	Datasink status ('ack' or 'nack')

Rule Object Properties

Parameter	Type	Description
entitlement	string	Entitlement ID (required)
justification	string array	List of raw justifications (required)

Body

```
{
  "rules": [
    {
      "entitlement": "string",
      "justification": [
        "string"
      ]
    }
  ]
}
```

```
    ]
  }
],
"is_autocertify": true,
"is_autorequest": true,
"autocertify_reason": "string",
"autorequest_reason": "string"
}
```

Example Request

```
curl -k -X POST \
'https://autoid-ui.forgerock.com/api/rules/decisions' \
-H 'Authorization: Bearer <token value>' \
-H 'Content-Type: application/json' \
-d '{
  "rules": [
    {
      "entitlement": "Ent_1",
      "justification": [
        "0C_CHIEF_YES_NO_Yes",
        "0C_JOBCODE_NAME_Service Representative II",
        "0C_MANAGER_NAME_John_Doe",
        "0C_USR_EMP_TYPE_Non-Employee"
      ]
    }
  ],
  "is_autocertify": true,
  "is_autorequest": false,
  "autocertify_reason": "Goodbye, world.",
  "autorequest_reason": "Hello, world."
}'
```

Example Response

```
Status 204: No Content
```

Filters

The following are Autonomous Identity Filters endpoints:

GET /api/filters/owner

GET /api/filters/owner

Get filterable attributes and values. [Supervisor, Ent Owner, Admin]

Endpoint

```
/api/filters/owner?by=supervisor&user=albert.pardini
```

Authorization

```
<Bearer Token JWT-value>
```

Query Parameters

```
by      supervisor, enttOwner  
user    albert.pardini
```

Example Request

```
curl --request GET "https://autoid-  
api.forgerock.com/api/filters/owner?  
by=supervisor&user=albert.pardini" \  
--header "Content-Type: application/json"
```

Example Response

```
{  
  "items": [  
    {  
      "title": "string",  
      "field": "string",  
      "filters": {  
        "field": "string",  
        "title": "string",
```

```
    "options": [  
      {  
        "text": "string",  
        "value": "string",  
        "count": 0  
      }  
    ]  
  }  
}  
]
```

GET /api/filters/app

GET /api/filters/app

Get filterable attributes and values. [App Owner, Admin]

Endpoint

```
/api/filters/app
```

Authorization

```
<Bearer Token JWT-value>
```

Query Parameters

```
id: application ID
```

Example Request

```
curl --request GET "https://autoid-  
api.forgerock.com/api/filters/app?id=app_1" \  
--header "Content-Type: application/json"
```

Example Response

```
{
  "items": [
    {
      "title": "string",
      "field": "string",
      "filters": {
        "field": "string",
        "title": "string",
        "options": [
          {
            "text": "string",
            "value": "string",
            "count": 0
          }
        ]
      }
    }
  ]
}
```

Roles

The following are Autonomous Identity filtering by roles endpoints:

POST /api/roles

POST /api/roles

Create draft roles and make updates to roles.

Endpoint

```
/api/roles
```

Authorization

```
<Bearer Token JWT-value> OR <API-KEY>
```

Request Body Parameters

Parameter	Type	Description
action	string	Action to perform ('create', 'save', 'publish', 'unpublish') (required)
updateAllMetadata	boolean	Update metadata for all related roles regardless of status
role	role object	Role object (properties below) (required)

Role Object Properties

Parameter	Type	Description
role_id	string	Role ID in uuid format (required)
status	string	Status of role ('draft', 'candidate', or 'active') (required)
custom_role	boolean	Role is a custom role
member_count	number	Number of users the roles applies to
assignment_count	number	Number of assignments the role applies to
entitlements	string array	List of entitlement IDs that are part of the role
justifications	string array	List of raw justifications
datasink_status	string	Datasink status ('ack' or 'nack')
role_metadata	role metadata object	Role metadata (properties below)
entitlements_metadata	array of entitlement metadata objects	List of entitlement metadata for each entitlement (object properties below)

Role Metadata Object Properties

Parameter	Type	Description
-----------	------	-------------

Parameter	Type	Description
role_name	string	Display name of role
description	string	Role description
role_owner_id	string	Role owner ID
role_owner_display_name	string	Role owner display name

Entitlement Metadata Object Properties

Parameter	Type	Description
ent_id	string	Entitlement ID (required)
ent_name	string	Entitlement name (required)
application	application object	Application metadata (object properties below)
entitlement_owner	owner object	Entitlement owner data (object properties below)

Application Object Properties

Parameter	Type	Description
app_id	string	Application ID
app_name	string	Application name
application_owner	owner object	Application owner data (object properties below)

Owner Object Properties

Parameter	Type	Description
usr_id	string	User ID (required)
usr_name	string	User name (required)
usr_manager_id	string	User manager ID (required)

Example Request

```
curl --location --request POST 'https://autoid-
api.forgerock.com/api/roles' \
--header 'Content-Type: application/json' \
--header 'Authorization: Bearer <token>' \
--data-raw '{
  "action": "save",
  "updateAllMetadata": false,
  "role": {
    "role_id": "3fa85f64-5717-4562-b3fc-2c963f66afa6",
    "status": "draft",
    "custom_role": false,
    "member_count": 0,
    "assignment_count": 0,
    "entitlements": [
      "string"
    ],
    "entitlements_metadata": [
      {
        "ent_id": "string",
        "ent_name": "string",
        "application": {
          "app_id": "string",
          "app_name": "string",
          "application_owner": {
            "usr_id": "string",
            "usr_name": "string",
            "usr_manager_id": "string"
          }
        },
        "entitlement_owner": {
          "usr_id": "string",
          "usr_name": "string",
          "usr_manager_id": "string"
        }
      }
    ],
    "justifications": [
      "string"
    ],
    "role_metadata": {
      "role_name": "string",
      "description": "string",
      "role_owner_display_name": "string",
      "role_owner_id": "string"
    }
  }
}
```



```
}  
}'
```

Example Response

```
204 (No Content)
```

POST /api/roles/delete

POST /api/roles/delete

Delete roles.

Endpoint

```
/api/roles/delete
```

Authorization

```
<Bearer Token JWT-value>
```

Body

```
{  
  "role_id": "3fa85f64-5717-4562-b3fc-2c963f66afa6",  
  "status": "draft" | "active"  
}
```

Example Request

```
curl --location --request POST 'https://autoid-  
api.forgerock.com/api/admin/updateSelf' \  
--header 'Content-Type: application/json' \  
--header 'Authorization: Bearer <token>' \  
--data-raw '{  
  "role_id": "3fa85f64-5717-4562-b3fc-2c963f66afa6",
```

```
"status": "draft" | "active"
}'
```

Example Response

```
204 (No content)
```

POST /api/roles/export

POST /api/roles/export

Export role data to json.

Endpoint

```
/api/roles/export
```

Authorization

```
<Bearer Token JWT-value> OR <API-KEY>
```

Query Parameters

Parameter	Type	Description
usrId	string	Roles that apply for a particular user ID
entId	string	Roles that apply for a particular entitlement ID
status	string	Status of role ('draft', 'candidate', or 'active')
role_name	string	Role name
description	string	Role description
role_owner_id	string	Role owner ID

Parameter	Type	Description
role_owner_display_name	string	Role owner name
datasinkStatus	string	Datasink status filter ('ack', 'nack')
timestampThresholds	object	Timestamp threshold object (available properties below)

timestampThresholds Object Properties

Parameter	Type	Description
gt	string	Greater than timestamp (format: yyyy-mm-ddThh:mm:ss.SSSZ). Cannot be present with gte .
gte	string	Greater than or equal timestamp (format: yyyy-mm-ddThh:mm:ss.SSSZ). Cannot be present with gt .
lt	string	Less than timestamp (format: yyyy-mm-ddThh:mm:ss.SSSZ). Cannot be present with lte .
lte	string	Less than or equal timestamp (format: yyyy-mm-ddThh:mm:ss.SSSZ). Cannot be present with le .

Body

```
{
  "usrId": "john.doe",
  "datasinkStatus": "nack"
}
```

Example Request (Datasink Filter)

```
curl -k -X POST \  
'https://autoid-ui.forgerock.com/api/roles/export' \  
--header 'Content-type: application/json' \  
--header 'Authorization: Bearer <token>' <OR> -H 'X-API-  
KEY: <api-key-value>' \  
--data-raw '{  
    "usrId": "john.doe",  
    "datasinkStatus": "nack"  
}'
```

Example Response (Datasink Filter)

```
{  
  "roles": [  
    {  
      "temp_role_name": "Role J0-R21",  
      "normalized_role_name": "role j0-r21",  
      "member_count": 1,  
      "assignment_count": 1,  
      "entitlement_count": 1,  
      "role_id": "4aaf81db-2f8c-42b4-b954-  
1018a71743de",  
      "status": "candidate",  
      "entitlements": [  
        "Ent_1"  
      ],  
      "entitlements_metadata": [  
        {  
          "ent_criticality": "Essential",  
          "ent_id": " Ent_1",  
          "ent_name": " Ent_1",  
          "ent_risk_level": "Low",  
          "application":  
            {  
              "app_criticality": "Essential",  
              "app_id": "Active Directory",  
              "app_name": "Active Directory",  
              "app_risk_level": "High",  
              "application_owner":  
                {  
                  "chief_yes_no": "Yes",  
                  "city": "Kansas City",  
                  "cost_center": "CON_SD9",
```

```

"department": "Facilities Area
A",
"is_active": "Y",
"job_description": "Facilities
Area A",
"jobcode_name": "Operating
Clerk",
"line_of_business": "Transmission
Operations",
"line_of_business_subgroup":
"Real Estate",
"manager_name": "Thomas Shawyer",
"usr_department_name":
"Facilities Area A",
"usr_display_name": "Derick Hui",
"usr_emp_type": "Non-Employee",
"usr_id": "derick.hui",
"usr_manager_id":
"thomas.shawyer",
"usr_name": "Derick Hui"
}
},
"entitlement_owner":
{
"chief_yes_no": "No",
"city": "Saint Paul",
"cost_center": "OP_TT4",
"department": "InfoSYS Power Gen",
"is_active": "Y",
"job_description": "InfoSYS Power
Gen",
"jobcode_name": "Lineman",
"line_of_business": "Ethics and
Compliance",
"line_of_business_subgroup":
"System Operations",
"manager_name": "James Bosch",
"usr_department_name": "InfoSYS
Power Gen",
"usr_display_name": "Carolyn
Latanafrancia",
"usr_emp_type": "Non-Employee",
"usr_id": "carolyn.latanafrancia",
"usr_manager_id": "james.bosch",
"usr_name": "Carolyn Latanafrancia"
}

```

```

        }
    },
    ],
    "justifications": [
        "0B_COST_CENTER_SOL_ER2
19_LINE_OF_BUSINESS_SUBGROUP_Energy%20Solutions"
    ],
    "users": [
        {
            "usr_id": "aaron.lozada",
            "usr_display_name": "Aaron Lozada",
            "attributes": [

"13_USR_DEPARTMENT_NAME_Operations%20SUP",

"0F_JOB_DESCRIPTION_Operations_%20SUP",
                "0C_JOBCODE_NAME_Apprentice",
                "0C_MANAGER_NAME_Gary%20Amelio",
                "09_IS_ACTIVE_Y",

"10_LINE_OF_BUSINESS_Distribution%20Operations",

"10_USR_DISPLAY_NAME_Aaron%20Lozada",
                "0B_COST_CENTER_SOL_ER2",
                "08_USR_NAME_Aaron%20Lozada",
                "0C_CHIEF_YES_NO_No",
                "0C_USR_EMP_TYPE_Employee",

"19_LINE_OF_BUSINESS_SUBGROUP_Energy%20Solutions",
                "04_CITY_Kansas%20City"
            ]
        }
    ]
}

```

Ingest

The following endpoints support the ingestion of base entities, such as applications, entitlements, identities, assignments, data sources, and mappings. New APIs introduced in this release are marked with .

To access these endpoints, you need a valid API key in the *X-API-KEY* header for authorization. To obtain an API key, see [Generate an API key](#).

POST /api/ingest/applications

POST /api/ingest/applications

Create, update, upsert, or delete application entities.

Endpoint

```
/api/ingest/applications
```

Authorization

```
<API Key-value>
```

Body Parameters

Parameter	Type	Description
action	string	Action to perform: create, update, upsert, delete (required)
apps	array	Array of application objects (properties below) (required)

Base Application Object Properties:

Parameter	Type	Description
app_id	string	Application ID (required)
app_name	string	Application Name
app_owner_id	string	Application owner user ID

Example Request

```
curl -k -X POST \
https://autoid-ui.forgerock.com/api/ingest/applications \
-H 'X-API-KEY: <api key value>' \
-H 'Content-Type: application/json' \
-d '{
  "action": "create",
  "apps": [
    {
      "app_id": "app1",
      "app_name": "Test App",
      "app_owner_id": "bob.rodgers"
    }
  ]
}'
```

Example Response

```
{
  "message": "ok"
}
```

POST /api/ingest/entitlements

POST /api/ingest/entitlements

Create, update, upsert, or delete entitlement entities.

Endpoint

```
/api/ingest/entitlements
```

Authorization

```
<API Key-value>
```

Body

Body Parameters

Parameter	Type	Description
action	string	Action to perform: create, update, upsert, delete (required)
entitlements	array	Array of entitlements objects (properties below) (required)

Base Entitlements Object Properties

Parameter	Type	Description
ent_id	string	Entitlement ID (required)
ent_name	string	Entitlement Name
ent_owner_id	string	Entitlement owner user ID
app_id	string	Application ID

Example Request

```
curl -k -X POST \
https://autoid-ui.forgerock.com/api/ingest/entitlements \
-H 'X-API-KEY: <api key value>' \
-H 'Content-Type: application/json' \
-d '{
  "action": "upsert",
  "entitlements": [
    {
      "ent_id": "ent1",
      "ent_name": "Test Ent",
      "ent_owner_id": "bob.rodgers",
      "app_id": "app1"
    }
  ]
}'
```

Example Response

```
{
  "message": "ok"
}
```

POST /api/ingest/identities

POST /api/ingest/identities

Create, update, upsert, or delete identity entities.

Endpoint

```
/api/ingest/identities
```

Authorization

```
<API Key-value>
```

Body Parameters

Parameter	Type	Description
action	string	Action to perform: create, update, upsert, delete (required)
entitlements	array	Array of identities objects (properties below) (required)

Base Entitlements Object Properties

Parameter	Type	Description
usr_id	string	User ID (required)
usr_name	string	User name
usr_manager_id	string	User's manager ID

Example Request

```
curl -k -X POST \
https://autoid-ui.forgerock.com/api/ingest/identities \
-H 'X-API-KEY: <api key value>' \
-H 'Content-Type: application/json' \
-d '{
  "action": "upsert",
  "identities": [
    {
      "usr_id": "john.doe",
      "usr_name": "John Doe",
      "usr_manager_id": "bob.rodgers"
    },
    {
      "usr_id": "jane.smith",
      "usr_name": "Jane Smith",
      "usr_manager_id": "bob.rodgers"
    }
  ]
}'
```

Example Response

```
{
  "message": "ok"
}
```

POST /api/ingest/assignments

POST /api/ingest/assignments

Create, update, upsert, or delete assignment entities.

Endpoint

```
/api/ingest/assignments
```

Authorization

```
<API Key-value>
```

Body Parameters

Parameter	Type	Description
action	string	Action to perform: create, update, upsert, delete (required)
entitlements	array	Array of assignment objects (properties below) (required)

Base Entitlements Object Properties

Parameter	Type	Description
ent_id	string	Entitlementd ID (required)
usr_id	string	User ID (required)

Example Request

```
curl -k -X POST \
https://autoid-ui.forgerock.com/api/ingest/assignments↗ \
-H 'X-API-KEY: <api key value>' \
-H 'Content-Type: application/json' \
-d '{
  "action": "upsert",
  "assignments": [
    {
      "usr_id": "john.doe",
      "ent_id": "ent1"
    },
    {
      "usr_id": "jane.smith",
      "ent_id": "ent1"
    }
  ]
}'
```

Example Response

```
{
  "message": "ok"
}
```

POST /api/ingest/datasources

POST /api/ingest/datasources

Get data sources. Optional filtering can be applied as a JSON request body outlined below:

Endpoint

```
/api/ingest/datasources
```

Authorization

```
<API Key-value>
```

Body Parameters

Parameter	Type	Description
datasourceId	string	Data source ID
name	string	Data source name
isActive	boolean	Data source activated
connectionTypes	string array	List of connection types to filter: jdbc, csv, generic
entityTypes	string array	List of entity types

Example Request

```
curl -k -X GET \
https://autoid-ui.forgerock.com/api/ingest/datasources↗ \
-H 'X-API-KEY: <api key value>' \
```

```
-H 'Content-Type: application/json' \  
-d '{  
  "connectionTypes": ["csv"],  
  "isActive": true  
}'
```

Example Response

```
[  
  {  
    "datasource_id": "fdbfb998-7b3e-4ddc-9e4a-  
a4c46cace49e",  
    "name": "Test data",  
    "sync_type": "full",  
    "icon": "apps",  
    "isActive": true,  
    "entityTypes": {  
      "/autoid/system/datasources/fdbfb998-7b3e-4ddc-9e4a-  
a4c46cace49e/applications": {  
        "uri": {  
          "file": "file:/data/input/applications.csv"  
        }  
      },  
      "/autoid/system/datasources/fdbfb998-7b3e-4ddc-9e4a-  
a4c46cace49e/assignments": {  
        "uri": {  
          "file": "file:/data/input/assignments.csv"  
        }  
      },  
      "/autoid/system/datasources/fdbfb998-7b3e-4ddc-9e4a-  
a4c46cace49e/entitlements": {  
        "uri": {  
          "file": "file:/data/input/entitlements.csv"  
        }  
      },  
      "/autoid/system/datasources/fdbfb998-7b3e-4ddc-9e4a-  
a4c46cace49e/identities": {  
        "uri": {  
          "file": "file:/data/input/identities.csv"  
        }  
      }  
    },  
    "connectionSettings": {
```

```
    "csv": {}
  }
}
```

POST /api/ingest/mappings

POST /api/ingest/mappings

Get mappings. Optional filtering can be applied as a JSON request body outlined below:

Endpoint

```
/api/ingest/mappings
```

Authorization

```
<API Key-value>
```

Body Parameters

Parameter	Type	Description
mappingId	string	Mapping ID
sourceEntity	string	Mapping source entity
targetEntity	string	Mapping target entity
sourceProperties	string array	List of source properties to filter on
targetProperties	string array	List of target properties to filter on

Example Request

```
curl -k -X GET \  
https://autoid-ui.forgerock.com/api/ingest/mappings↗ \  

```

```
-H 'X-API-KEY: <api key value>' \  
-H 'Content-Type: application/json' \  
-d '{  
  "targetProperties": ["app_id", "app_name"]  
}'
```

Example Response

```
[  
  {  
    "mapping_id": "fb6896e5-8d0a-4bd7-b10d-5608c9a953a1",  
    "source_entity": "/autoid/system/datasources/0474f92c-  
d530-43cc-a012-29fb6c8b3b8b/applications",  
    "target_entity": "/autoid/base/applications",  
    "properties": [  
      {  
        "source": "APP_ID",  
        "target": "app_id",  
        "apply": true  
      },  
      {  
        "source": "APP_NAME",  
        "target": "app_name",  
        "apply": true  
      },  
      {  
        "source": "APP_OWNER_ID",  
        "target": "app_owner_id",  
        "apply": true  
      }  
    ]  
  }  
]
```

Jobs

You can define, run, and get the status of each job using REST API endpoints. When using REST calls, the available job types are the following:

- ingest

- train
- mine
- predict-as-is
- recommend
- load
- create-assignment-index
- create-assignment-index-report
- anomaly
- insight
- audit

The following are Autonomous Identity jobs endpoints:

POST /api/job_definition

POST /api/job_definition

Set up a job definition.

Endpoint

```
/api/job_definition
```

Authorization

```
Bearer <Token JWT-value> or  
<API Key-value>
```

Body

```
{  
  "branch": "actual",  
  "contextId": "40c20f01-a9d8-4284-b290-c8b6ccdb8b77",  
  "entityData": [  
    {  
      "job_name": "ShowCaseCSVAnomaly",  
      "job_type": "anomaly",  
      "job_parameters": {  
        "driverMemory": "2g",
```

```

        "driverCores": 3,
        "executorMemory": "3G",
        "executorCores": 6
    }
}
],
"indexingRequired": true,
"tags": {},
"indexInSync": true
}

```

NOTE

contextId is a unique identifier string. It can be anything you define.

Example Request

```

curl 'https://autoid-
ui.forgerock.com/jas/entity/persist/autoid/api/job_definiti
on' \
  -H 'authority: autoid-ui.forgerock.com' \
  -H 'sec-ch-ua: "Chromium";v="92", " Not A;Brand";v="99",
"Google Chrome";v="92"' \
  -H 'accept: application/json, text/plain, /' \
  -H 'x-tenant-id: 8700f5cb-eaca-461e-8c2e-245a25f2399d' \
  -H 'authorization: 1b7789f0-6c2f-4afa-a84b-a65a28f5c1a1'
\
  -H 'sec-ch-ua-mobile: ?0' \
  -H 'user-agent: Mozilla/5.0 (Macintosh; Intel Mac OS X
10_15_7) AppleWebKit/537.36 (KHTML, like Gecko)
Chrome/92.0.4515.131 Safari/537.36' \
  -H 'content-type: application/json' \
  -H 'origin: https://autoid-ui.forgerock.com' \
  -H 'sec-fetch-site: same-origin' \
  -H 'sec-fetch-mode: cors' \
  -H 'sec-fetch-dest: empty' \
  -H 'referrer: https://autoid-ui.forgerock.com/jobs' \
  -H 'accept-language: en-US,en;q=0.9' \
  --data-raw '{
        "branch": "actual",
        "contextId": "40c20f01-a9d8-4284-b290-
c8b6ccdb8b77",
        "entityData": [

```

```

        {
          "job_name": "ShowCaseCSVAnomaly",
          "job_type": "anomaly",
          "job_parameters": {
            "driverMemory": "2g",
            "driverCores": 3,
            "executorMemory": "3G",
            "executorCores": 6
          }
        },
        "indexingRequired": true,
        "tags": {},
        "indexInSync": true
      }' \
--compressed \
--insecure
}
}'

```

The Job definition for data ingestion requires a `datasourceId`, which you can query. Refer to API key examples.

Example Request (ingest)

```

curl 'https://autoid-
ui.forgerock.com/jas/entity/persist/autoid/api/job_definiti
on' \
  -H 'authority: autoid-ui.forgerock.com' \
  -H 'sec-ch-ua: "Chromium";v="92", " Not A;Brand";v="99",
"Google Chrome";v="92"' \
  -H 'accept: application/json, text/plain, /' \
  -H 'x-tenant-id: 8700f5cb-eaca-461e-8c2e-245a25f2399d' \
  -H 'authorization: 1b7789f0-6c2f-4afa-a84b-a65a28f5c1a1'
\
  -H 'sec-ch-ua-mobile: ?0' \
  -H 'user-agent: Mozilla/5.0 (Macintosh; Intel Mac OS X
10_15_7) AppleWebKit/537.36 (KHTML, like Gecko)
Chrome/92.0.4515.131 Safari/537.36' \
  -H 'content-type: application/json' \
  -H 'origin: https://autoid-ui.forgerock.com' \
  -H 'sec-fetch-site: same-origin' \
  -H 'sec-fetch-mode: cors' \
  -H 'sec-fetch-dest: empty' \

```

```
-H 'referer: https://autoid-ui.forgerock.com/jobs' \
-H 'accept-language: en-US,en;q=0.9' \
--data-raw '{
    "branch": "actual",
    "contextId": "ba9cefff-1e06-4cc3-b7d6-
d15e2126351c",
    "entityData": [
        {
            "job_name": "ShowCaseCSVIngest",
            "job_type": "ingest",
            "job_parameters": {
                "driverMemory": "2g",
                "driverCores": 3,
                "executorMemory": "3G",
                "executorCores": 6,
                "datasourceId": "2d7a6a76-469c-4035-
b312-fb1daf104e98"
            }
        }
    ],
    "indexingRequired": true,
    "tags": {},
    "indexInSync": true
}' \
--compressed \
--insecure
```

POST /jas/job/run

POST /jas/job/run

Run the job definition.

Endpoint

```
/jas/job/run
```

Authorization

```
Bearer <Token JWT-value> or  
<API Key-value>
```

Body

```
{
  "jobType":"ingest",
  "jobDefinitionName":"ShowCaseCSVIngest"
}
```

Example Request

```
curl 'https://autoid-ui.forgerock.com/jas/job/run' \
  -H 'authority: autoid-ui.forgerock.com' \
  -H 'sec-ch-ua: "Chromium";v="92", " Not A;Brand";v="99",
  "Google Chrome";v="92"' \
  -H 'accept: application/json, text/plain, /' \
  -H 'x-tenant-id: 8700f5cb-eaca-461e-8c2e-245a25f2399d' \
  -H 'authorization: 1b7789f0-6c2f-4afa-a84b-a65a28f5c1a1' \
  \
  -H 'sec-ch-ua-mobile: ?0' \
  -H 'user-agent: Mozilla/5.0 (Macintosh; Intel Mac OS X
  10_15_7) AppleWebKit/537.36 (KHTML, like Gecko)
  Chrome/92.0.4515.131 Safari/537.36' \
  -H 'content-type: application/json' \
  -H 'origin: https://autoid-ui.forgerock.com' \
  -H 'sec-fetch-site: same-origin' \
  -H 'sec-fetch-mode: cors' \
  -H 'sec-fetch-dest: empty' \
  -H 'referrer: https://autoid-ui.forgerock.com/jobs' \
  -H 'accept-language: en-US,en;q=0.9' \
  --data-raw '{
    "jobType":"ingest",
    "jobDefinitionName":"ShowCaseCSVIngest"
  }' \
  --compressed \
  --insecure
```

GET /jas/job/status

GET /jas/job/status

Obtain the job's status.

Endpoint

```
/jas/job/status
```

Authorization

```
Bearer <Token JWT-value> or  
<API Key-value>
```

Body

```
{  
  "jobType": "anomaly",  
  "jobDefinitionName": "ShowCaseCSVAnomaly"  
}
```

Example Request

```
curl 'https://autoid-ui.forgerock.com/jas/job/status' \  
  -H 'authority: autoid-ui.forgerock.com' \  
  -H 'sec-ch-ua: "Chromium";v="92", " Not A;Brand";v="99",  
"Google Chrome";v="92"' \  
  -H 'accept: application/json, text/plain, /' \  
  -H 'x-tenant-id: 8700f5cb-eaca-461e-8c2e-245a25f2399d' \  
  -H 'authorization: 1b7789f0-6c2f-4afa-a84b-a65a28f5c1a1'  
 \  
  -H 'sec-ch-ua-mobile: ?0' \  
  -H 'user-agent: Mozilla/5.0 (Macintosh; Intel Mac OS X  
10_15_7) AppleWebKit/537.36 (KHTML, like Gecko)  
Chrome/92.0.4515.131 Safari/537.36' \  
  -H 'content-type: application/json' \  
  -H 'origin: https://autoid-ui.forgerock.com' \  
  -H 'sec-fetch-site: same-origin' \  
  -H 'sec-fetch-mode: cors' \  
  -H 'sec-fetch-dest: empty' \  
  -H 'referrer: https://autoid-ui.forgerock.com/jobs' \  
  -H 'accept-language: en-US,en;q=0.9' \  
  --data-raw '{  
    "jobType": "anomaly",
```

```
    "jobDefinitionName": "ShowCaseCSVAnomaly"  
  }' \  
  --compressed \  
  --insecure
```

GET /jas/job/search

GET /jas/job/search

Search for a job definition.

Endpoint

```
/jas/job/search
```

Authorization

```
Bearer <Token JWT-value> or  
<API Key-value>
```

Body

```
{  
  "query": {  
    "sort": [  
      {  
        "job_name.keyword": {  
          "order": "asc"  
        }  
      },  
      {  
        "metadata.primaryKey.keyword": {  
          "order": "desc"  
        }  
      }  
    ],  
    "size": 10,  
    "track_total_hits": true,  
    "query": {  
      "match_all": {}  
    }  
  }  
}
```

```
}
}
}
```

Example Request

```
curl 'https://autoid-
ui.forgerock.com/jas/entity/search/autoid/api/job_definitio
n' \
  -H 'authority: autoid-ui.forgerock.com' \
  -H 'sec-ch-ua: "Chromium";v="92", " Not A;Brand";v="99",
"Google Chrome";v="92"' \
  -H 'accept: application/json, text/plain, /' \
  -H 'x-tenant-id: 8700f5cb-eaca-461e-8c2e-245a25f2399d' \
  -H 'authorization: 1b7789f0-6c2f-4afa-a84b-a65a28f5c1a1'
\
  -H 'sec-ch-ua-mobile: ?0' \
  -H 'user-agent: Mozilla/5.0 (Macintosh; Intel Mac OS X
10_15_7) AppleWebKit/537.36 (KHTML, like Gecko)
Chrome/92.0.4515.131 Safari/537.36' \
  -H 'content-type: application/json' \
  -H 'origin: https://autoid-ui.forgerock.com' \
  -H 'sec-fetch-site: same-origin' \
  -H 'sec-fetch-mode: cors' \
  -H 'sec-fetch-dest: empty' \
  -H 'referrer: https://autoid-ui.forgerock.com/jobs' \
  -H 'accept-language: en-US,en;q=0.9' \
  --data-raw '{
    "query": {
      "sort": [
        {
          "job_name.keyword": {
            "order": "asc"
          }
        },
        {
          "metadata.primaryKey.keyword": {
            "order": "desc"
          }
        }
      ],
      "size": 10,
      "track_total_hits": true,
```



```

        "query": {
            "match_all": {}
        }
    }
}' \
--compressed \
--insecure

```

Data Sink

Data sink is the downstream consumer of data within Autonomous Identity for service connectors and is accessible through API endpoints.

▼ [See a conceptual image of Data Sink](#)

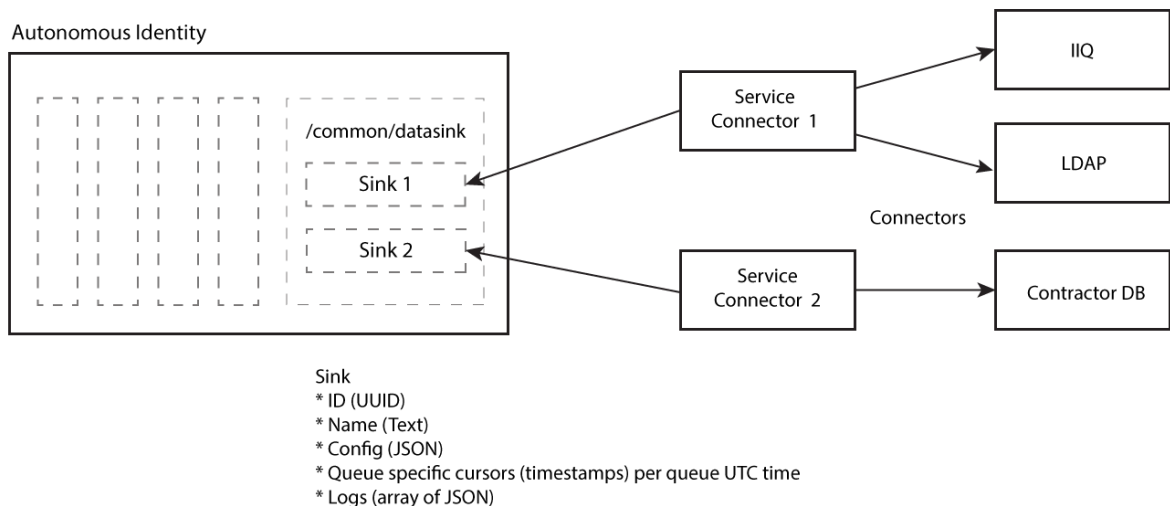

The following are Autonomous Identity datasink endpoints:

POST /api/datasink/create

POST /api/datasink/create

Create a new /common/datasink entity.

Endpoint

/api/datasink/create

Authorization

<Bearer Token JWT-value>

JSON Body Parameters

Parameter	Type	Description
id	string	Data sink ID (format: UUID) (required)
name	string	Data sink name (required)
config	object	Free form client-defined connection object
autoCertifyTimestamp	string	Last auto-certification operation timestamp (format: yyyy-mm-ddThh:mm:ss.SSSZ)
autoRequestTimestamp	string	Last auto-request operation timestamp (format: yyyy-mm-ddThh:mm:ss.SSSZ)
certifyTimestamp	string	Last certification operation timestamp (format: yyyy-mm-ddThh:mm:ss.SSSZ)
revokeTimestamp	string	Last revoke operation timestamp (format: yyyy-mm-ddThh:mm:ss.SSSZ)
rolePublishTimestamp	string	Last role publish timestamp (format: yyyy-mm-ddThh:mm:ss.SSSZ)
logs	object	Free form client-defined log object

Example Request

```
curl -k -X POST https://autoid-  
ui.forgerock.com/api/datasink/create'  \  
-H 'Authorization: Bearer <token value>' \  
-H 'Content-Type: application/json' \  
-d '{  
  "id": "eaa19702-3806-4ee7-9466-91f0968699d9",  
  "name": "Test",
```

```
"config": { "something": 1234 }
}'
```

Example Response (Success)

```
{
  "message": "ok"
}
```

POST /api/datasink/update

POST /api/datasink/update

Update a /common/datasink entity.

Endpoint

```
/api/datasink/update
```

Authorization

```
<Bearer Token JWT-value>
```

JSON Body Parameters

Parameter	Type	Description
id	string	Data sink ID (format: UUID) (required)
name	string	Data sink name (required)
config	object	Free form client-defined connection object
autoCertifyTimestamp	string	Last auto-certification operation timestamp (format: yyyy-mm-ddThh:mm:ss.SSSZ)

Parameter	Type	Description
autoRequestTimestamp	string	Last auto-request operation timestamp (format: yyyy-mm-ddThh:mm:ss.SSSZ)
certifyTimestamp	string	Last certification operation timestamp (format: yyyy-mm-ddThh:mm:ss.SSSZ)
revokeTimestamp	string	Last revoke operation timestamp (format: yyyy-mm-ddThh:mm:ss.SSSZ)
rolePublishTimestamp	string	Last role publish timestamp (format: yyyy-mm-ddThh:mm:ss.SSSZ)
logs	object	Free form client-defined log object

Example Request

```
curl -k -X POST https://autoid-
ui.forgerock.com/api/datasink/update' \
-H 'Authorization: Bearer <token value>' \
-H 'Content-Type: application/json' \
-d '{
  "id": "eaa19702-3806-4ee7-9466-91f0968699d9",
  "name": "Test3",
  "config": { "something": 5678 }
}'
```

Example Response (Success)

```
{
  "message": ok
}
```

POST /api/datasink/delete

POST /api/datasink/delete

Remove a /common/datasink entity.

Endpoint

```
/api/datasink/delete
```

Authorization

```
<Bearer Token JWT-value>
```

JSON Body Parameters

Parameter	Type	Description
id	string	Data sink ID (format: UUID) (required)

Example Request

```
curl -k -X POST https://autoid-  
ui.forgerock.com/api/datasink/delete' \ \\  
-H 'Authorization: Bearer <token value>' \\  
-H 'Content-Type: application/json' \\  
-d '{  
  "id": "eaa19702-3806-4ee7-9466-91f0968699d9"  
'
```

Example Response (Success)

```
{  
  "message": ok  
}
```

POST /api/datasink/update/status/assignments

POST /api/datasink/update/status/assignments

Update data sink status for assignment decisions. Decisions are stored in the `/autoid/api/user_access_decisions` JAS entity and `entitlement-assignment` Elasticsearch index.

Endpoint

```
/api/datasink/update/status/assignments
```

Authorization

```
<API Key>
```

JSON Body Parameters

Parameter	Type	Description
assignments	array	Array of assignment objects (properties below) (required)

Base Assignment Object Properties

Parameter	Type	Description
user	string	User ID (required)
entitlements	string array	Array of entitlement IDs (required)
datasink_status	string	Updated data sink status (required)

Example Request

```
curl -k -X POST \
https://autoid-
ui.forgerock.com/api/datasink/update/status/assignments \
-H 'X-API-KEY: <api key value>' \
-H 'Content-Type: application/json' \
-d '{
  "assignments": [
    {
```

```
"user": "john.doe",
"entitlements": [
  "entitlement_1"
],
"datasink_status": "ack"
},
{
  "user": "jane.smith",
  "entitlements": [
    "entitlement_1",
    "entitlement_2",
  ],
  "datasink_status": "nack"
}
]
}'
```

Example Response (Success)

```
{
  "message": ok
}
```

POST /api/datasink/update/status/rules

POST /api/datasink/update/status/rules

Update data sink status for rule decisions. Decisions are stored in the `/autoid/api/rule_access_decisions` JAS entity and `entitlement-assignment` Elasticsearch index.

Endpoint

```
/api/datasink/update/status/rules
```

Authorization

```
<API Key>
```

JSON Body Parameters

Parameter	Type	Description
rules	array	Array of rule objects (properties below) (required)

Base Rules Object Properties

Parameter	Type	Description
entitlement	string	Entitlement ID (required)
justification	string array	Array of justifications (required)
datasink_status	string	Updated data sink status (required)

Example Request

```
curl -k -X POST \
https://autoid-
ui.forgerock.com/api/datasink/update/status/rules \
-H 'X-API-KEY: <api key value>' \
-H 'Content-Type: application/json' \
-d '{
  "rules": [
    {
      "entitlement": "entitlement_1",
      "justification": [
        "0B_COST_CENTER_OP_TS5",
        "0C_USR_EMP_TYPE_Non-Employee",
        "10_LINE_OF_BUSINESS_Health and Safety",
        "13_USR_DEPARTMENT_NAME_Testing"
      ],
      "datasink_status": "nack"
    }
  ]
}'
```

Example Response (Success)

```
{
  "message": ok
}
```

POST /api/datasink/update/status/roles

POST /api/datasink/update/status/roles

Update data sink status for exported roles.

Endpoint

```
/api/datasink/update/status/roles
```

Authorization

```
<API Key>
```

JSON Body Parameters

Parameter	Type	Description
roles	array	Array of role objects (properties below) (required)

Base Roles Object Properties

Parameter	Type	Description
role_id	string	Role ID (required)
status	string	Role status (draft, candidate, active) (required)
datasink_status	string	Updated data sink status (required)

Example Request

```
curl -k -X POST \  
/https://autoid-  
ui.forgerock.com/api/datasink/update/status/roles \  
-H 'X-API-KEY: <api key value>' \  
-H 'Content-Type: application/json' \  
-d '{  
  "roles": [  
    {  
      "role_id": "027d9a1d-9a2f-488a-8ab2-adf404e0aecb",  
      "status": "draft",  
      "datasink_status": "nack"  
    }  
  ]  
'
```

Example Response (Success)

```
{  
  "message": ok  
}
```

POST /api/datasink/query

POST /api/datasink/query

Query data sink entities. Optional filtering can be applied as a JSON request body outlined below.

Endpoint

```
/api/datasink/query
```

Authorization

```
<API Key>
```

JSON Body Parameters

Parameter	Type	Description
id	string	Data sink ID (format: UUID)
name	string	Data sink name
autoCertifyTimestamp	object	Last auto-certify operation timestamp filter object (available properties below)
autoRequestTimestamp	object	Last auto-request operation timestamp filter object (available properties below)
certifyTimestamp	object	Last certify operation timestamp filter object (available properties below)
revokeTimestamp	object	Last revoke operation timestamp filter object (available properties below)
rolePublishTimestamp	object	Last role publish timestamp filter object (available properties below)

timestampThresholds Object Properties

Parameter	Type	Description
gt	string	Greater than timestamp (format: yyyy-mm-ddThh:mm:ss.SSSZ). Cannot be present with gte .
gte	string	Greater than or equal timestamp (format: yyyy-mm-ddThh:mm:ss.SSSZ). Cannot be present with gt .
lt	string	Less than timestamp (format: yyyy-mm-ddThh:mm:ss.SSSZ). Cannot be present with lte .
lte	string	Less than or equal timestamp (format: yyyy-mm-ddThh:mm:ss.SSSZ). Cannot be present with le .

Example Request

```
curl -k -X POST \
https://autoid-ui.forgerock.com/api/datasink/query \
-H 'X-API-KEY: <api key value>' \
-H 'Content-Type: application/json' \
-d '{
  "name": "IIQ",
  "certifyTimestamp": {
    "gt": "2021-11-19T10:01:19.937Z",
    "lte": "2021-11-20T10:01:19.937Z"
  }
}'
```

Example Response (Success)

```
[
  {
    "id": "b72c15b7-7dcb-44ac-b1d3-162565e360b4",
    "name": "IIQ",
    "certifyTimestamp": "2021-11-19T11:01:19.937Z",
    "auto_request_timestamp": "2021-10-01T10:01:19.937Z"
  },
  {
    "id": "9501810e-1480-4f41-80d4-bc97154fddeb",
    "name": "IIQ",
    "certifyTimestamp": "2021-11-20T09:01:19.937Z",
    "auto_request_timestamp": "2021-10-01T10:01:19.937Z"
  }
]
```

POST /api/datasink/update/timestamp

POST /api/datasink/update/timestamp

Update timestamps for a data sink entity.

Endpoint

```
/api/datasink/update/timestamp
```

Authorization

<API Key>

JSON Body Parameters

Parameter	Type	Description
id	string	Data sink ID (format: UUID)
autoCertifyTimestamp	object	Last auto-certify operation timestamp filter object (format: yyyy-mm-ddThh:mm:ss.SSSZ)
autoRequestTimestamp	object	Last auto-request operation timestamp filter object (format: yyyy-mm-ddThh:mm:ss.SSSZ)
certifyTimestamp	object	Last certify operation timestamp filter object (format: yyyy-mm-ddThh:mm:ss.SSSZ)
revokeTimestamp	object	Last revoke operation timestamp filter object (format: yyyy-mm-ddThh:mm:ss.SSSZ)
rolePublishTimestamp	object	Last role publish timestamp filter object (format: yyyy-mm-ddThh:mm:ss.SSSZ)

Example Request

```
curl -k -X POST \
https://autoid-
ui.forgerock.com/api/datasink/update/timestamp \
-H 'X-API-KEY: <api key value>' \
-H 'Content-Type: application/json' \
-d '{
  "id": "87e341c0-c1aa-4b0e-9ae5-1384bb6de8fc",
  "certifyTimestamp": "2021-11-19T10:01:19.937Z",
  "revokeTimestamp": "2021-11-19T10:01:19.937Z"
}'
```

Example Response (Success)

```
{
  "message": "ok"
}
```

POST /api/datasink/query/logs

POST /api/datasink/query/logs

Query data sink logs. Optional filtering can be applied as a JSON request body outlined below.

Endpoint

```
/api/datasink/query/logs
```

Authorization

```
<API Key>
```

JSON Body Parameters

Parameter	Type	Description
id	string	Data sink ID (format: UUID)
name	string	Data sink name

Example Request

```
curl -k -X POST \
https://autoid-ui.forgerock.com/api/datasink/query/logs \
-H 'X-API-KEY: <api key value>' \
-H 'Content-Type: application/json' \
-d '{
```

```
"name": "IIQ"
}'
```

Example Response (Success)

```
[
  {
    "id": "5f8c48c5-8f70-43a0-a9a6-61d1b017dac7",
    "name": "IIQ",
    "certify_timestamp": "2021-10-01T10:01:19.937Z",
    "revokeTimestamp": "2021-10-23T10:01:19.937Z",
    "logs": [
      {
        "message": "log 1"
      },
      {
        "message": "log 2"
      }
    ]
  },
  {
    "id": "9c68c658-2d7d-487c-a0ce-6d9cdcc7eaf7",
    "name": "IIQ",
    "certify_timestamp": "2021-10-01T10:01:19.937Z",
    "revokeTimestamp": "2021-10-01T10:01:19.937Z",
    "logs": [
      {
        "message": "log 1"
      },
      {
        "message": "log 2"
      }
    ]
  }
]
```

POST /api/datasink/update/logs

POST /api/datasink/update/logs

Update data sink logs.

Endpoint

```
/api/datasink/update/logs
```

Authorization

```
<API Key>
```

JSON Body Parameters

Parameter	Type	Description
id	string	Data sink ID (format: UUID) (required)
logs	object	JSON logs object (required)

Example Request

```
curl -k -X POST \
https://autoid-ui.forgerock.com/api/datasink/update/logs \
-H 'X-API-KEY: <api key value>' \
-H 'Content-Type: application/json' \
-d '{
  "id": "87e341c0-c1aa-4b0e-9ae5-1384bb6de8fc",
  "logs": {
    "logs": [
      {
        "created": "2021-11-19T09:01:19.937Z",
        "type": "INFO",
        "message": "transaction started"
      },
      {
        "created": "2021-11-19T10:01:19.937Z",
        "type": "INFO",
        "message": "transaction successful"
      }
    ]
  }
}'
```

Example Response (Success)

```
{  
  "message": "ok"  
}
```